

TA 4135 > 13DH474A643 (2006) > SITZWANNE

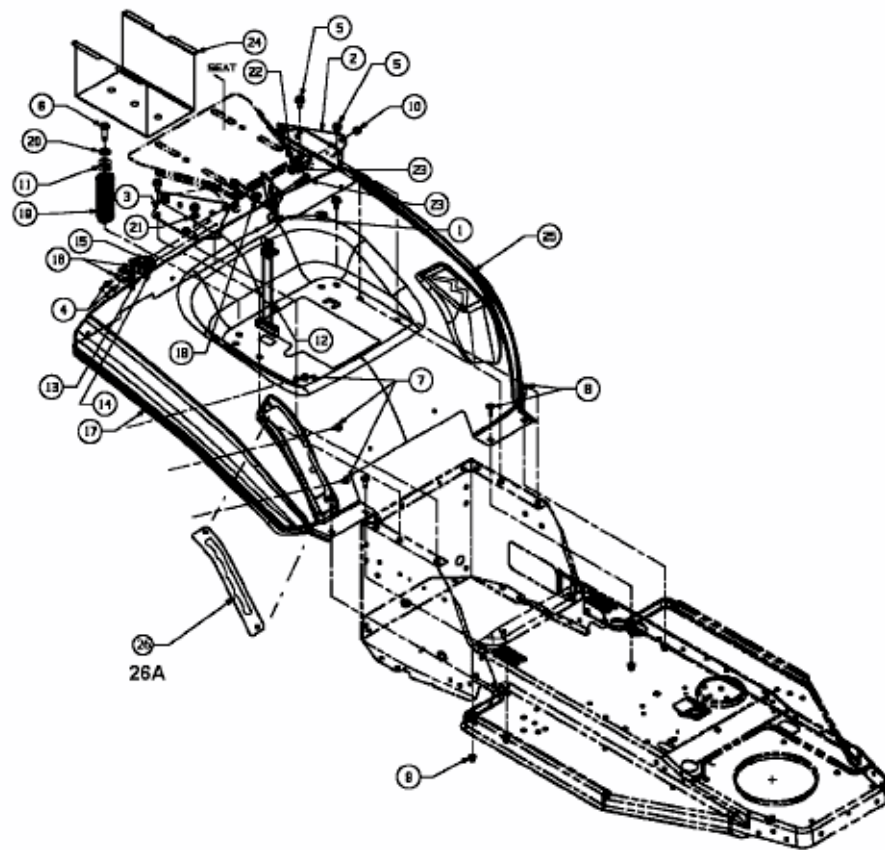

E3-02097A-01