

TA 4120 > 13DH474A643 (2005) > TRITTBRETTBELAG

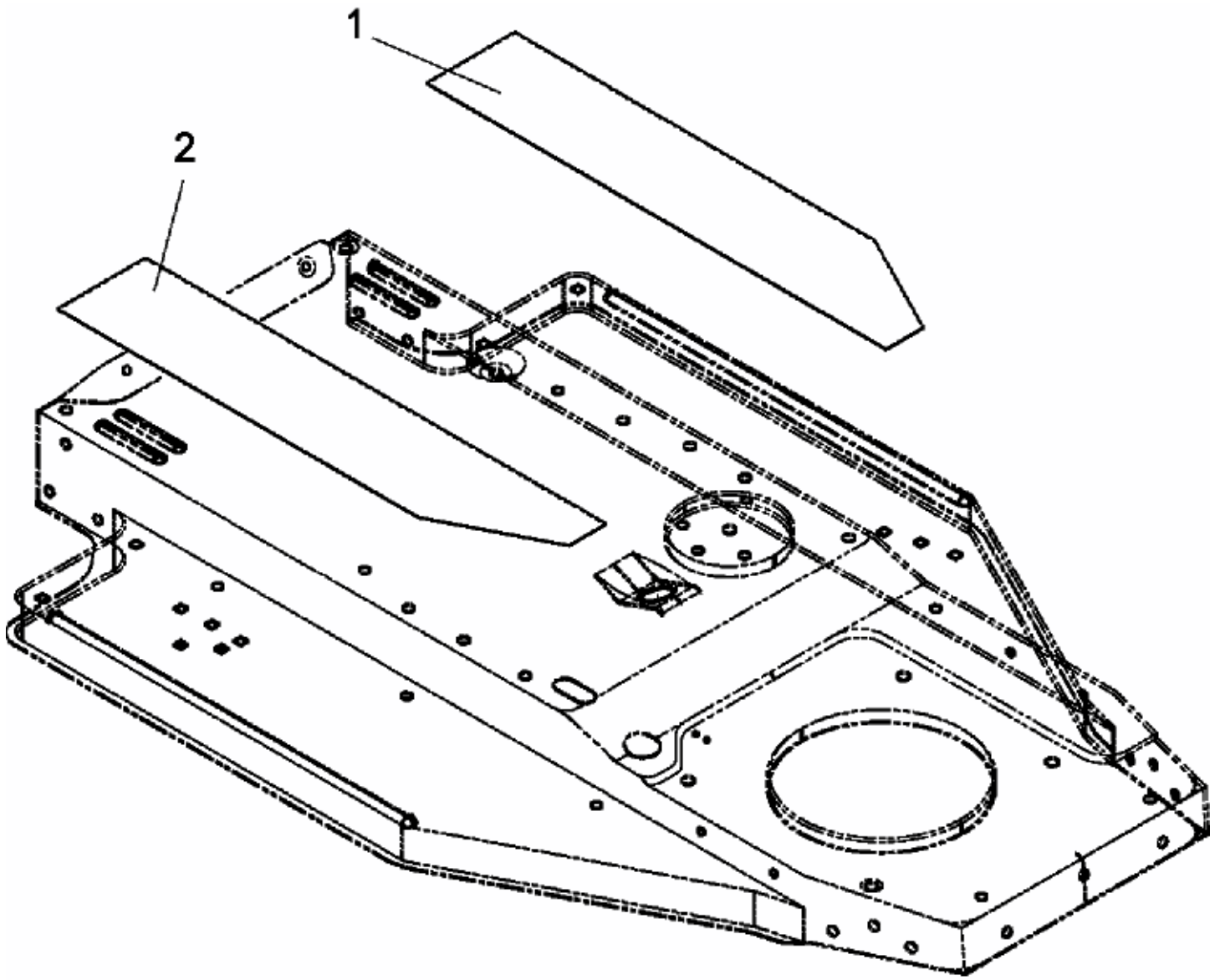

E3-02106B-01