

TA 4120 > 13DH474A643 (2005) > VORDERACHSE

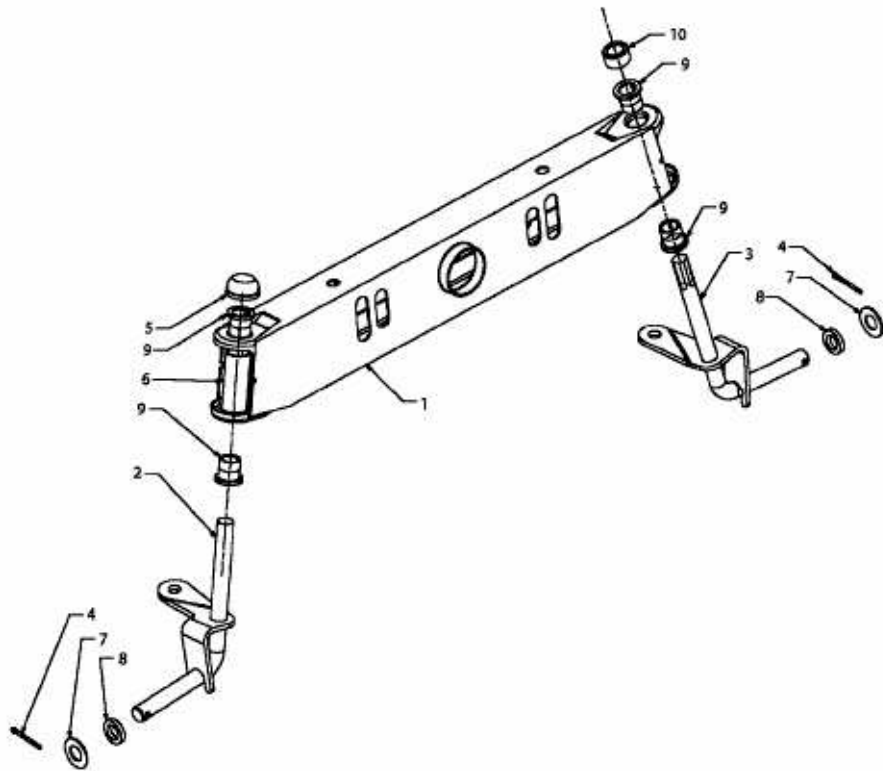

E3-02101A-01