

TA 4135 > 13DH474A443 (2007) > RAHMEN

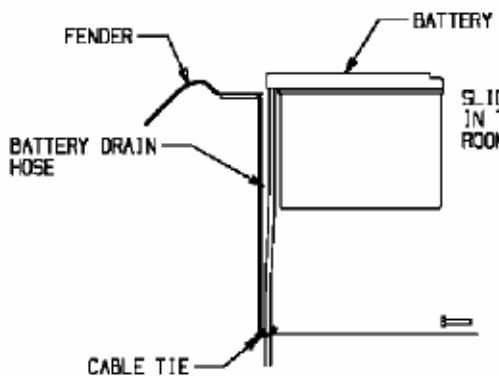
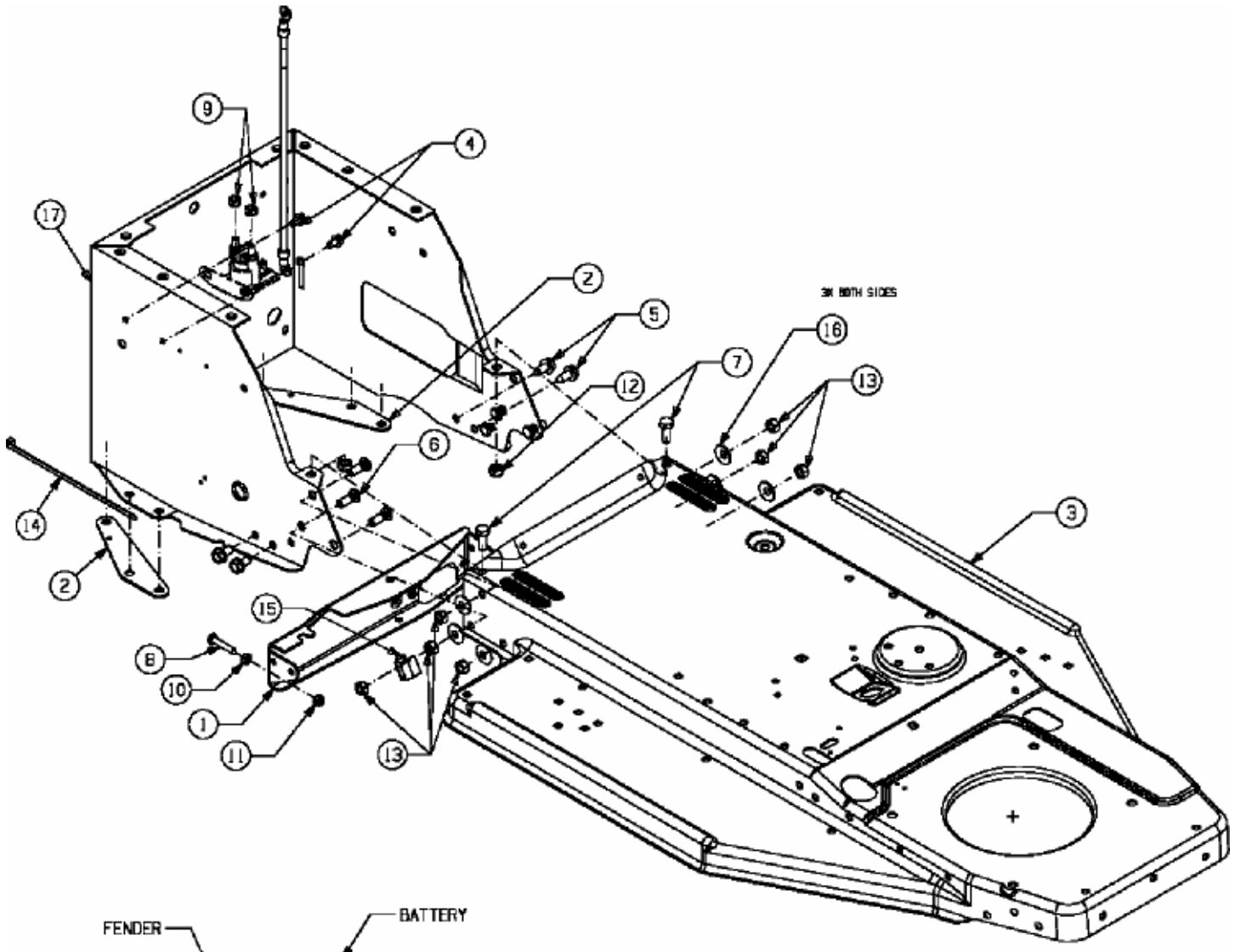

SLIDE THE BATTERY FORWARD
IN THE BATTERY TRAY TO MAKE
ROOM FOR THE HOSE BEHIND THE BATTERY

E3-02094B-01