

TA 4135 > 13DH474A443 (2007) > GRASFANGSACK

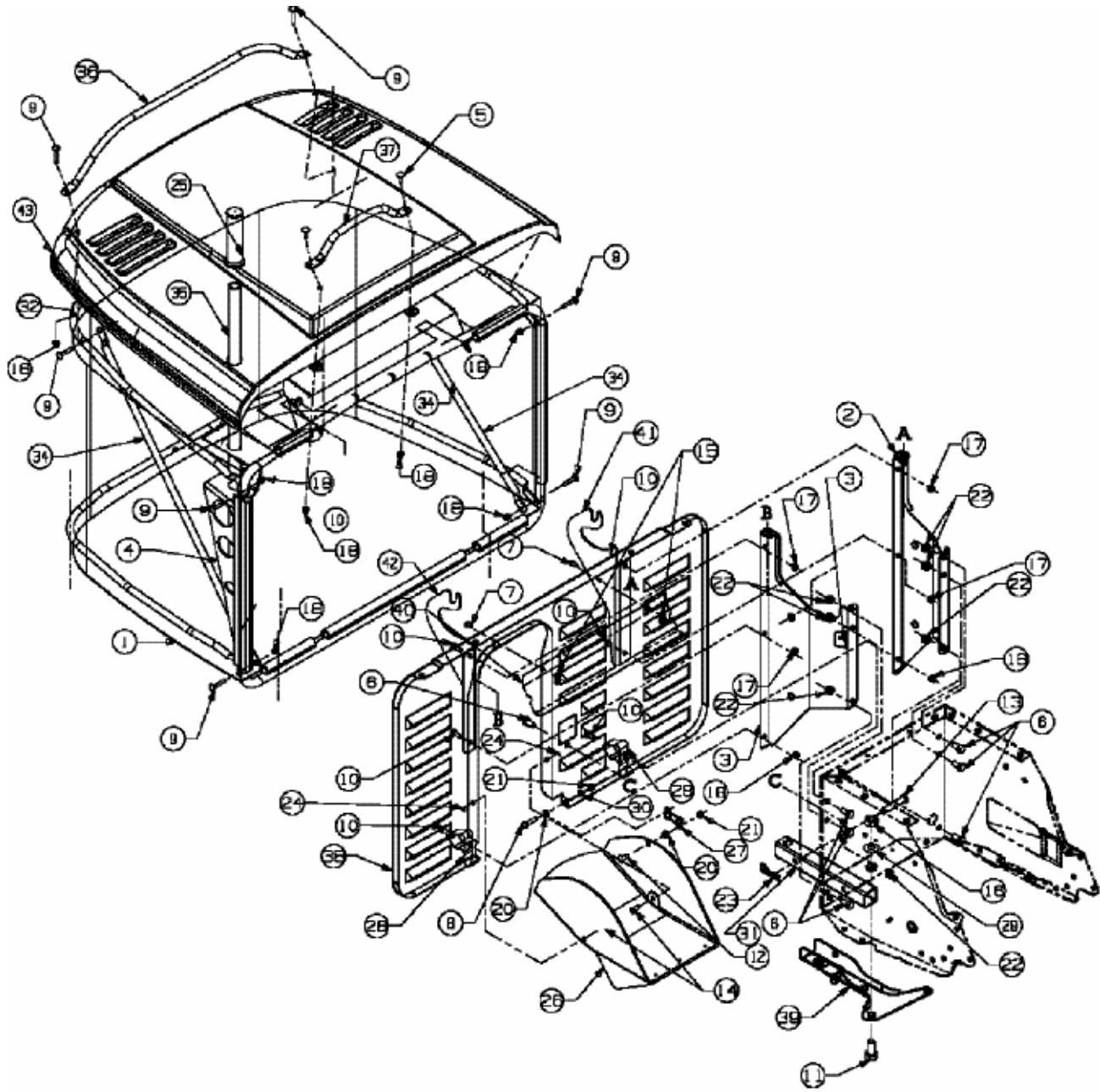

E3-02155C-01