

TE 4125 > 13DH473E643 (2007) > RAHMEN

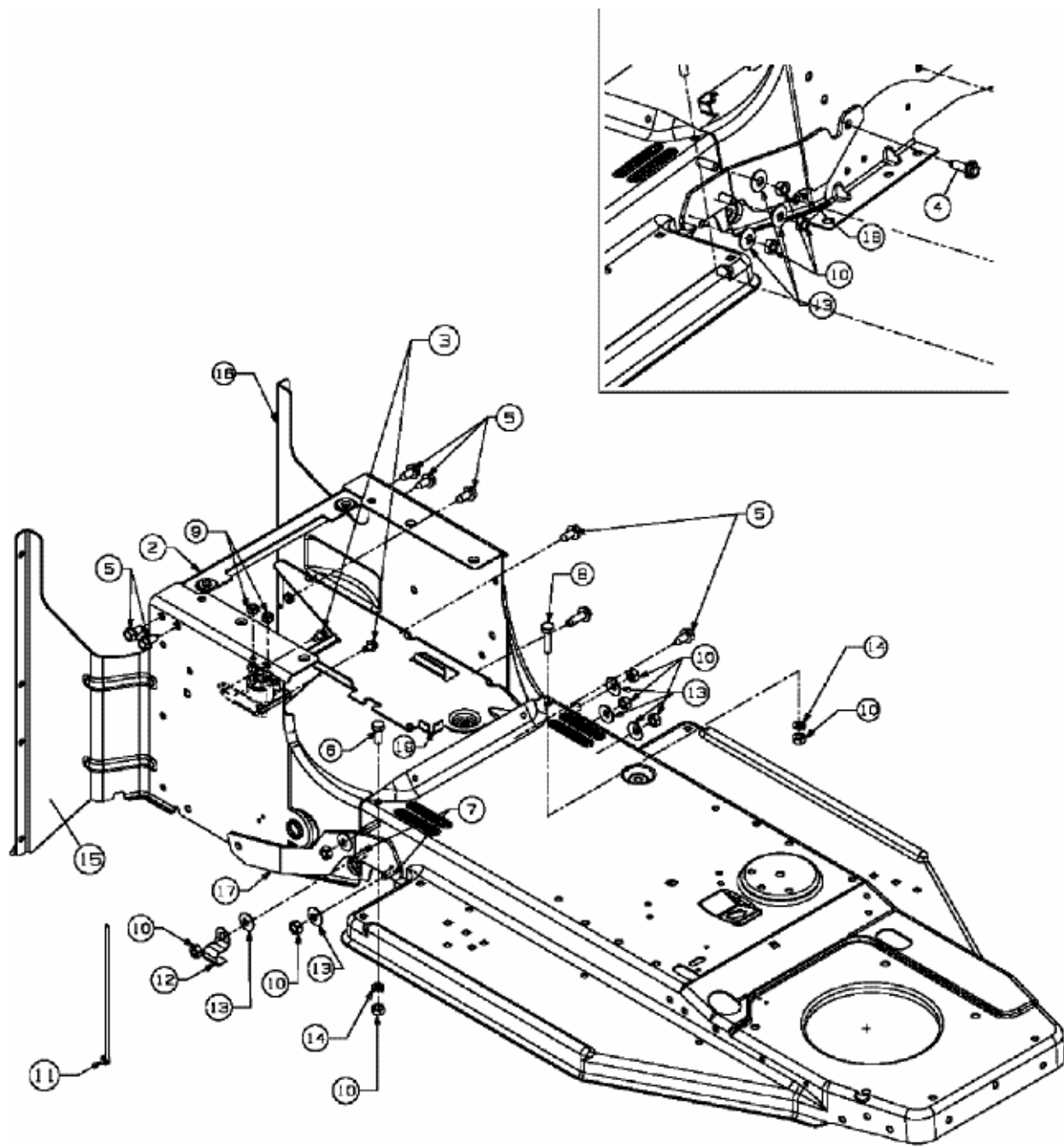

E3-02095B-01