

TE 4125 > 13DH473E643 (2007) > MÄHWERKSEINSCHALTUNG

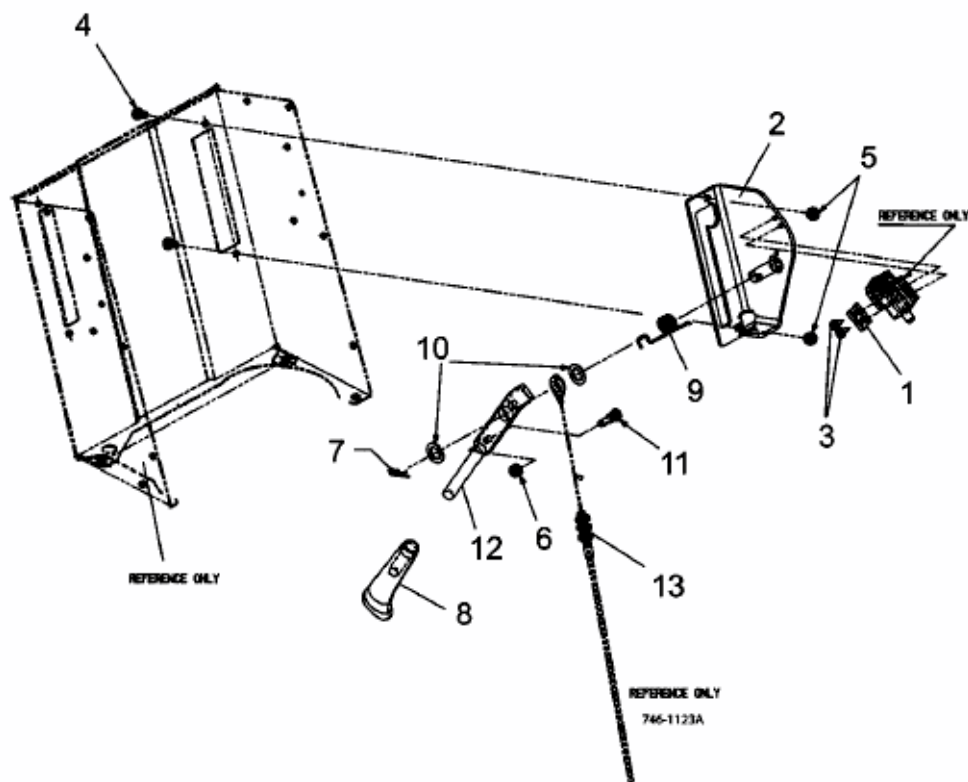

E3-02223A-01