

TE 4125 > 13DH473E643 (2007) > ARMATURENBRETT

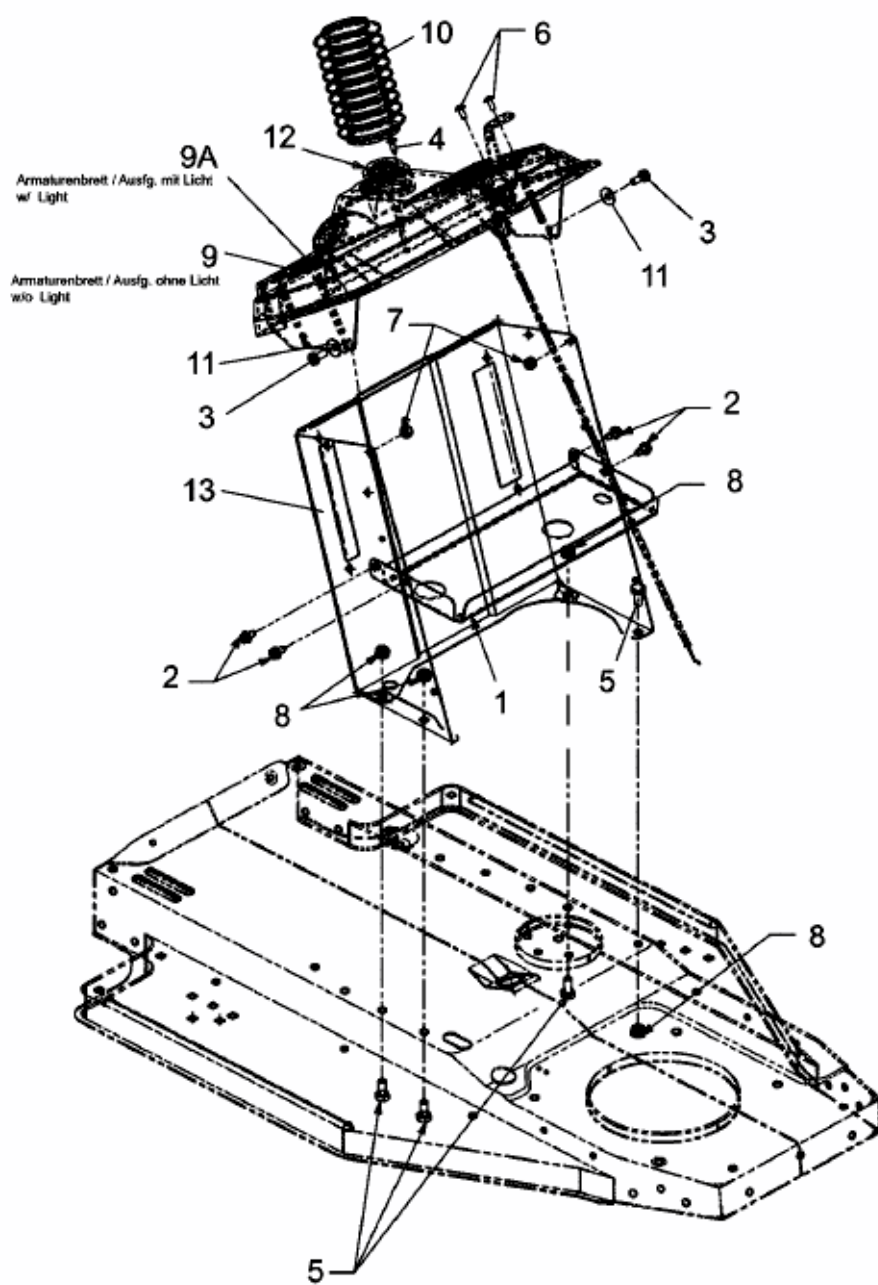

E3-02134A-01