

TE 4125 > 13DH473E643 (2007) > GESCHWINDIGKEITSREGELUNG

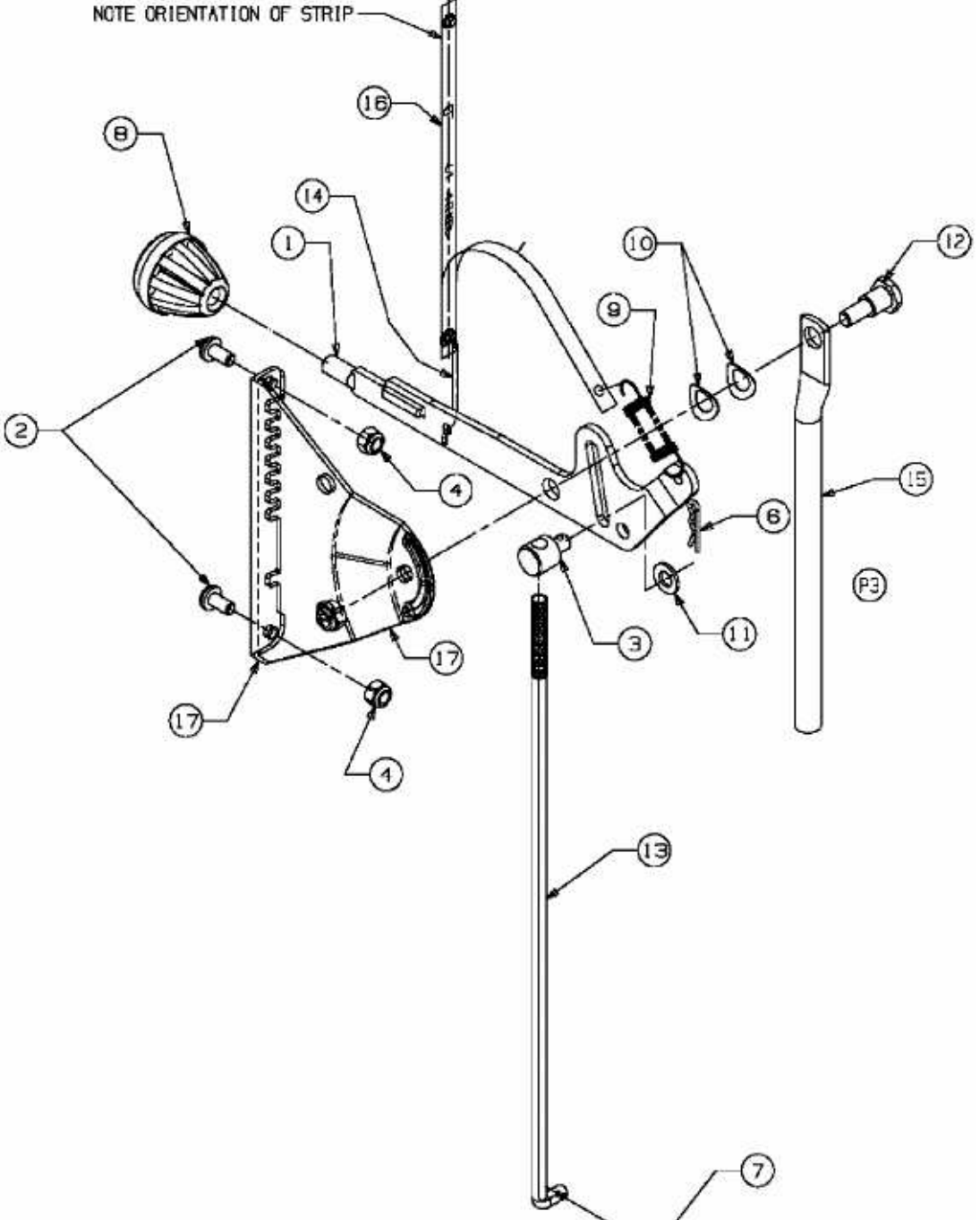

E3-02113A-01