

TE 4125 > 13DH473E643 (2007) > TRITTBRETTBELAG

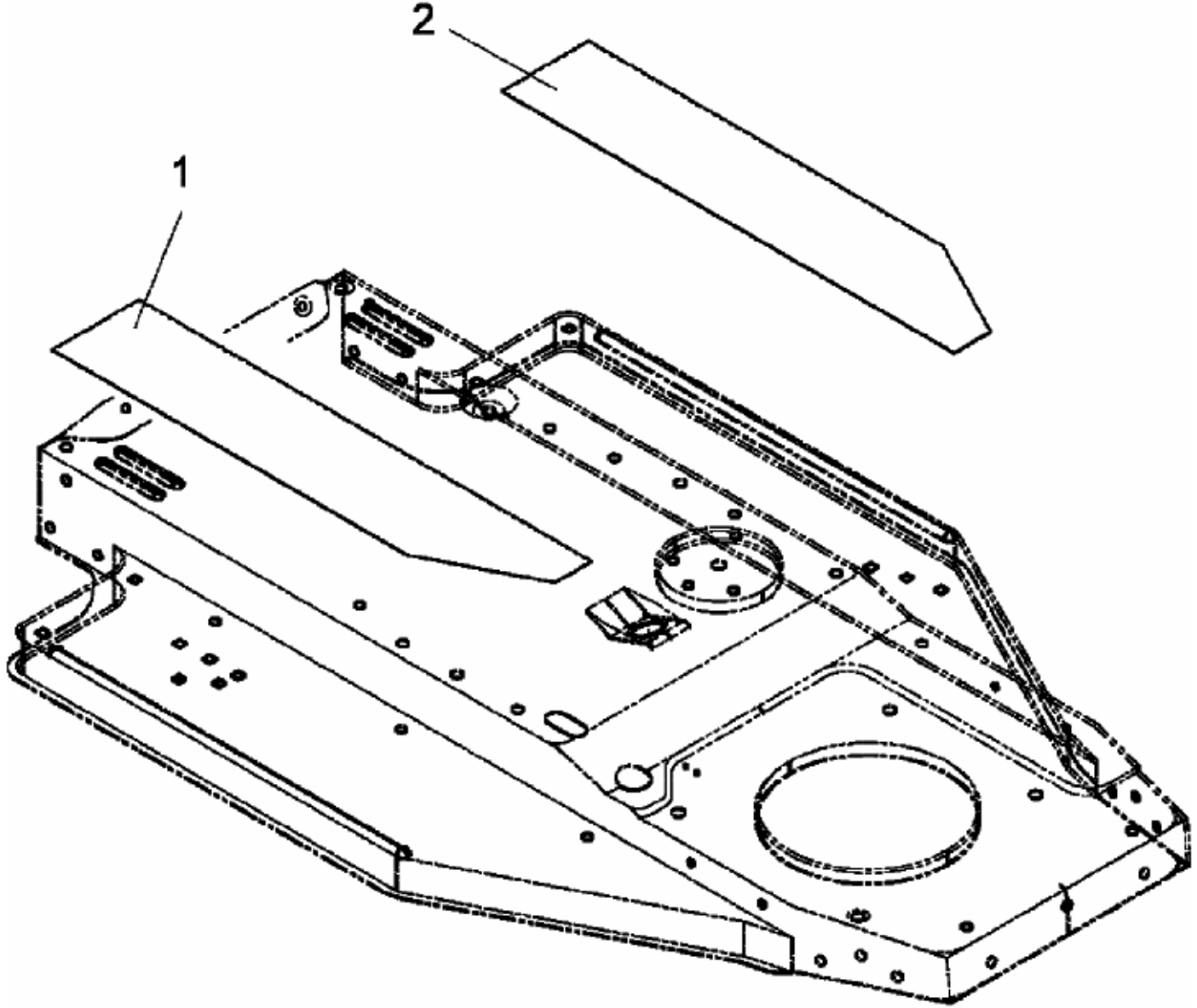

E3-02108A-01