

TE 4125 > 13DH473E643 (2006) > MOTORKEILRIEMENSCHLEIBE

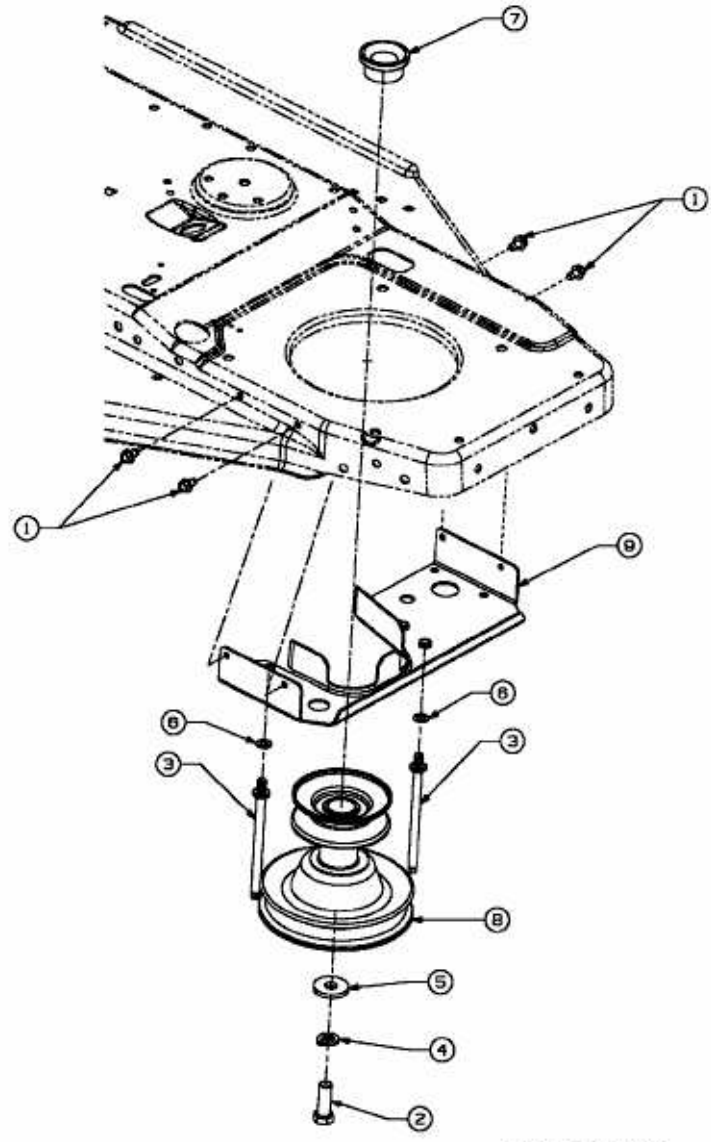

E3-02111A-01