

TE 4125 > 13DH473E643 (2006) > SITZWANNE

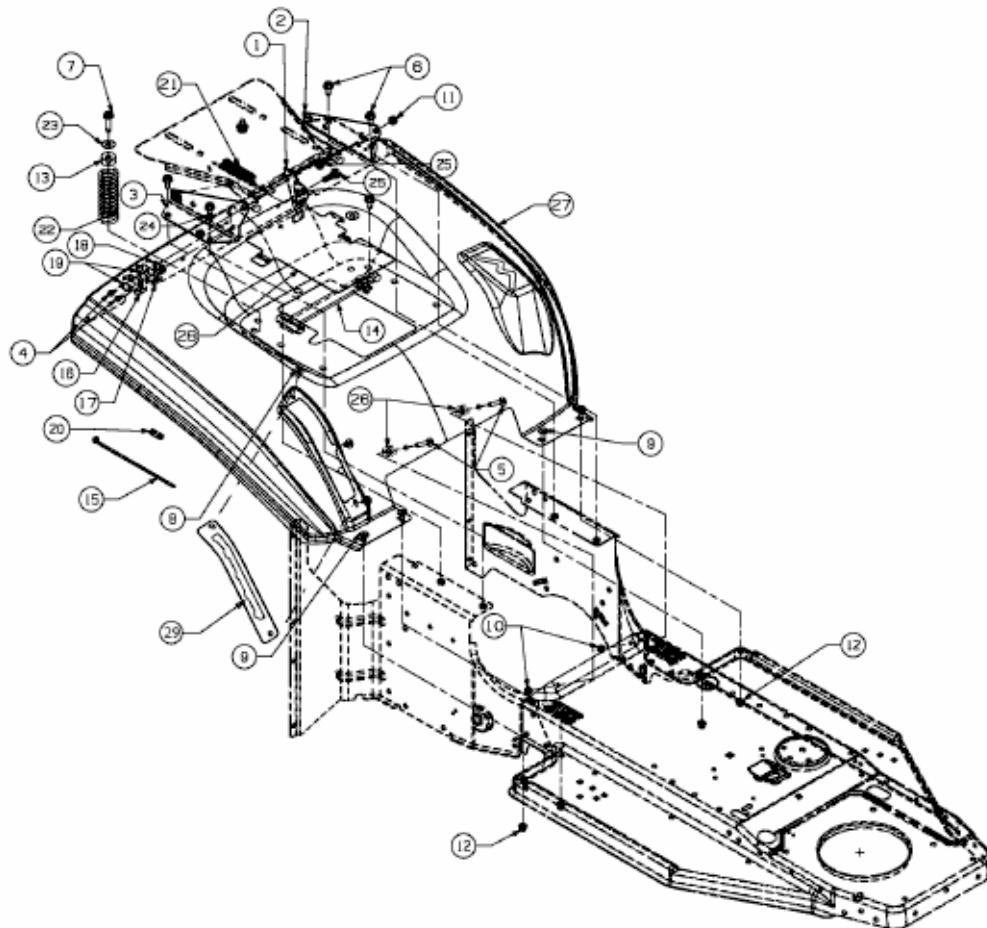

E3-02098A-01