

603 > 13DH473C611 (2007) > LENKRAD MIT LOGO

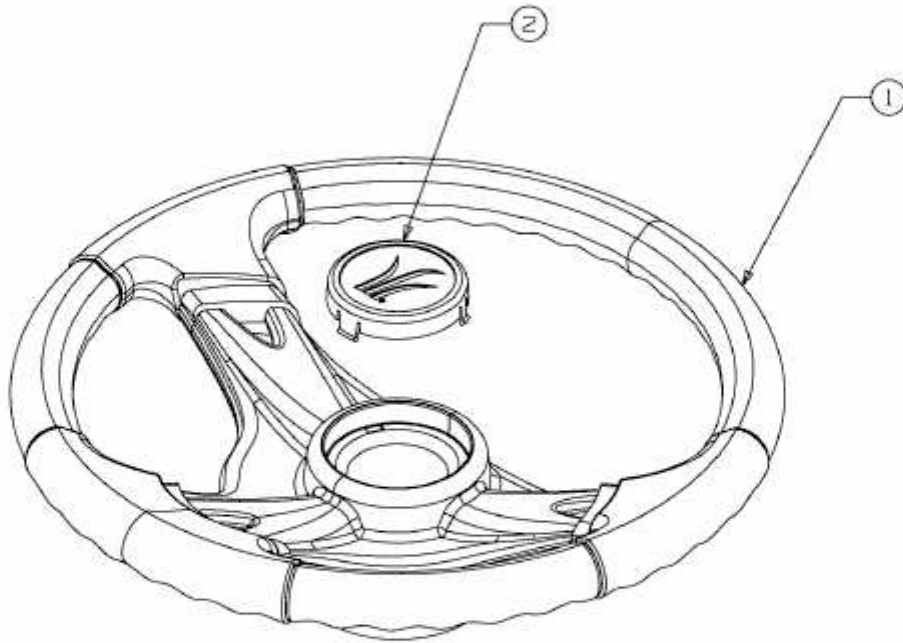

E3-02014A-01