

603 > 13DH473C611 (2007) > GESCHWINDIGKEITSREGELUNG

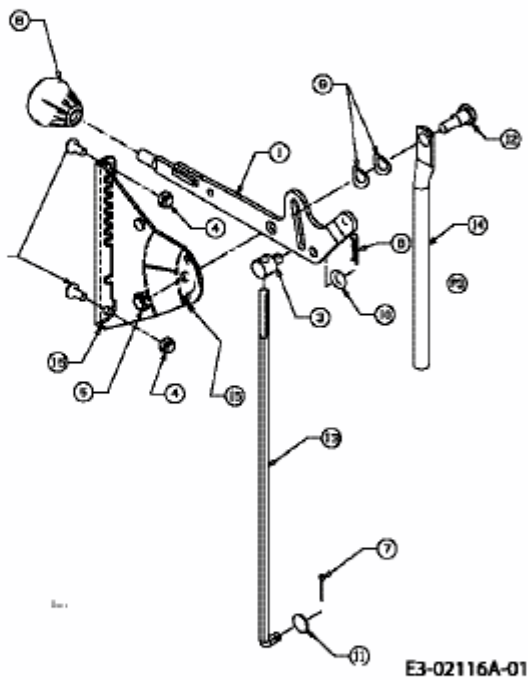

E3-02116A-01