

B 125/96 T > 13DH458F683 (2007) > GESCHWINDIGKEITSREGELUNG

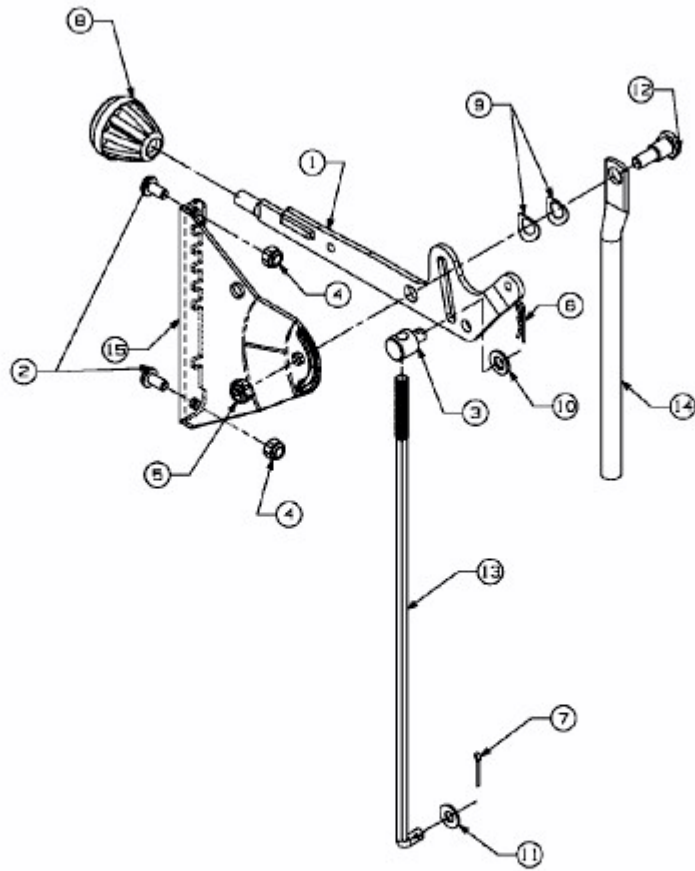

E3-02115A-01