

RH 115 B > 13DH458C600 (2005) > GESCHWINDIGKEITSREGELUNG

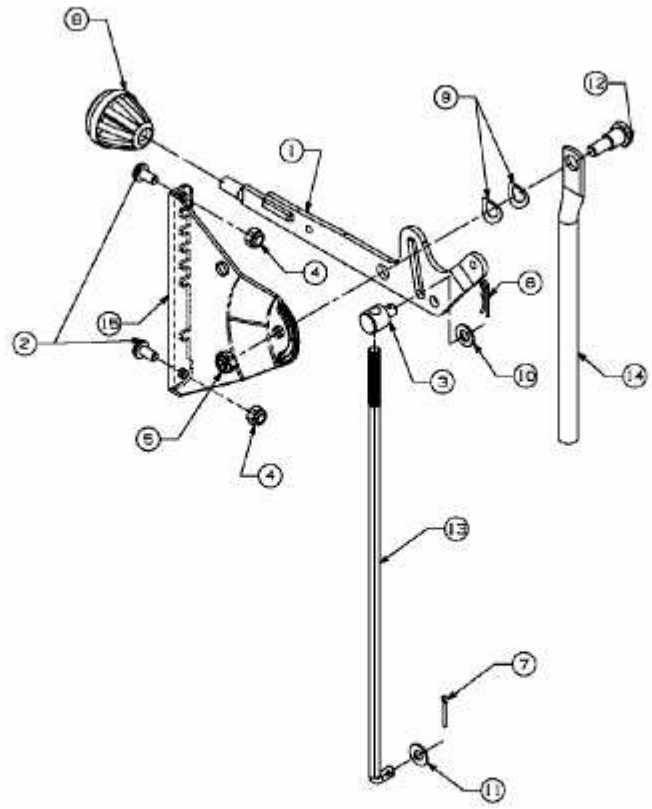

E3-02115A-01