

SPIDER 76 RD > 13DH452C676 (2008) > GESCHWINDIGKEITSREGELUNG

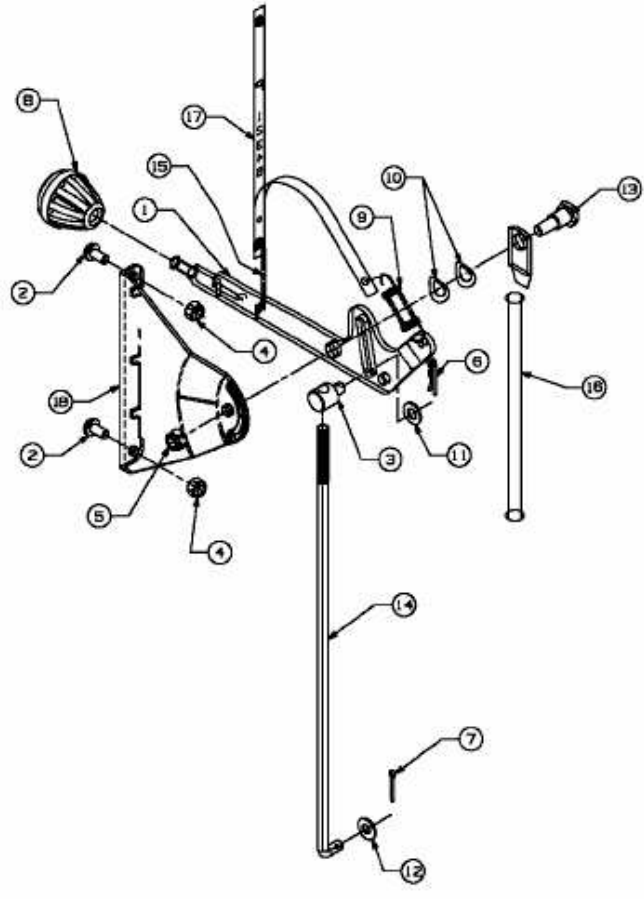

E3-02112A-01