

TA 4120 > 13DC474A643 (2004) > VORDERACHSE

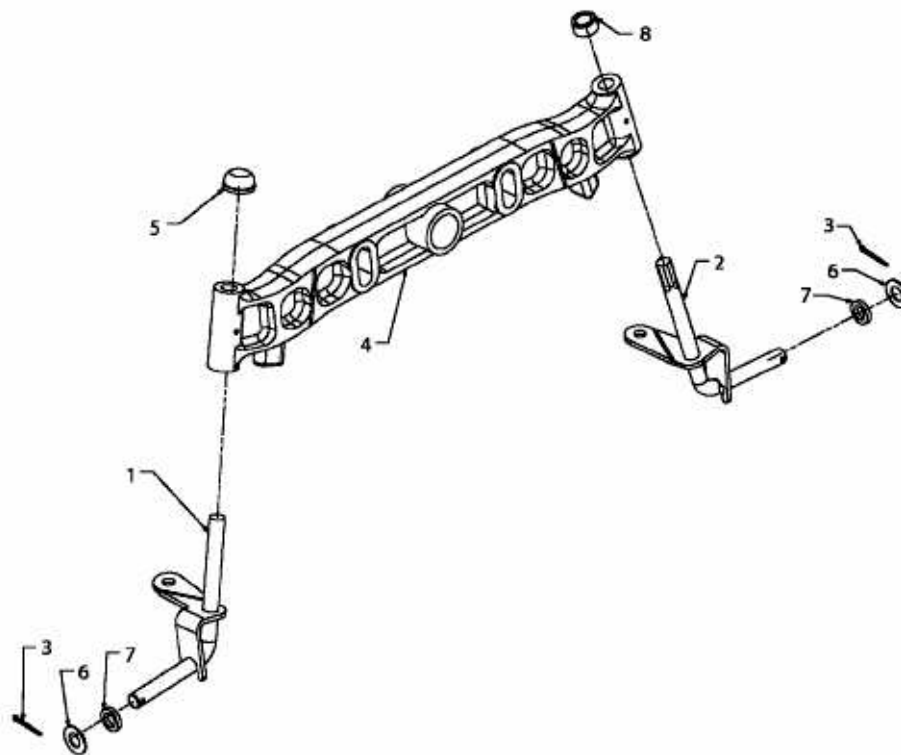

E3-02102A-01