

RH 125/92 > 13D1458E622 (2006) > TRITTBRETTBELAG

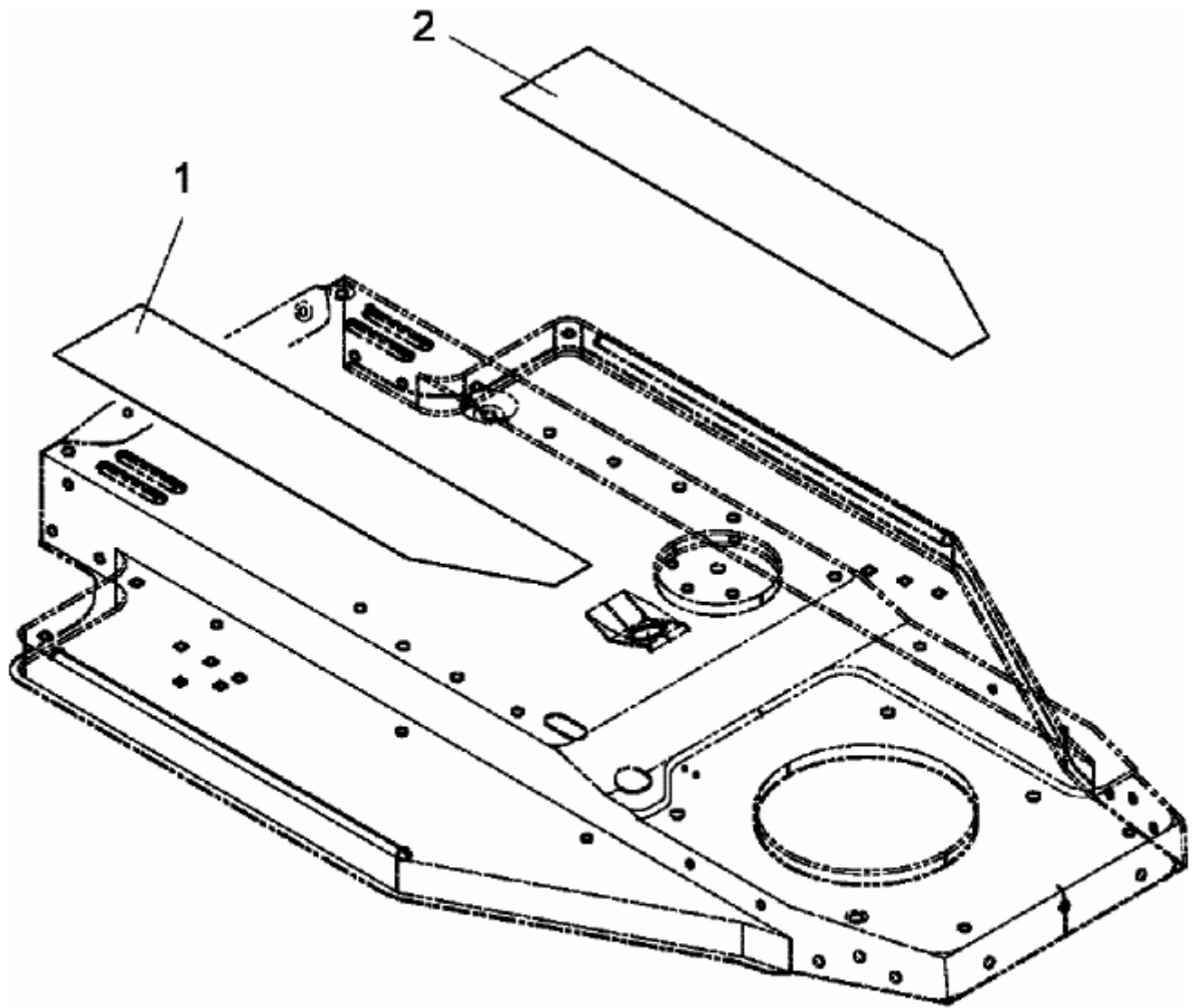

E3-02108A-01