

RS 125/96 > 13D1452F600 (2006) > MOTORHAUBE 2-STYLE BIS 31.03.2008

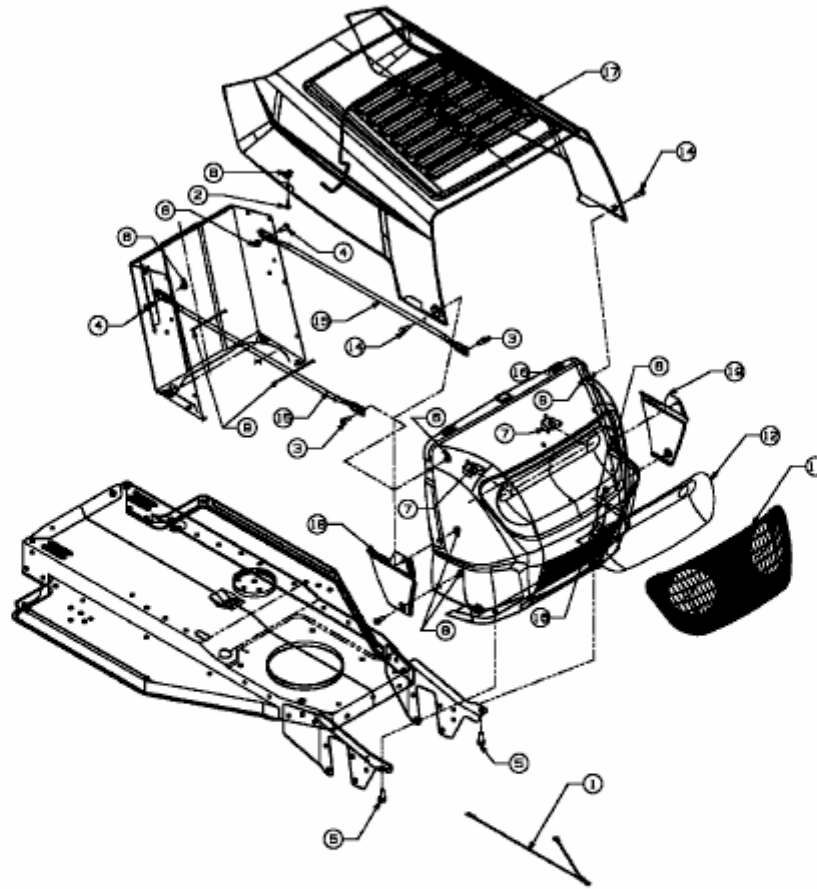

E3-02058A-01