

RS 125/96 > 13D1452F600 (2006) > GESCHWINDIGKEITSREGELUNG

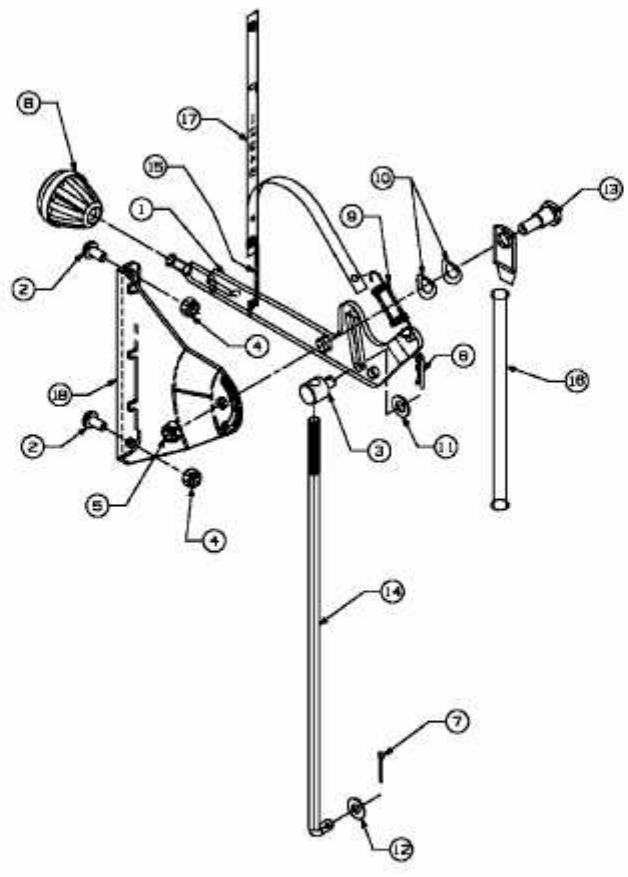

E3-02112A-01