

RS 115/96 > 13D1452F600 (2005) > ARMATURENBRETT

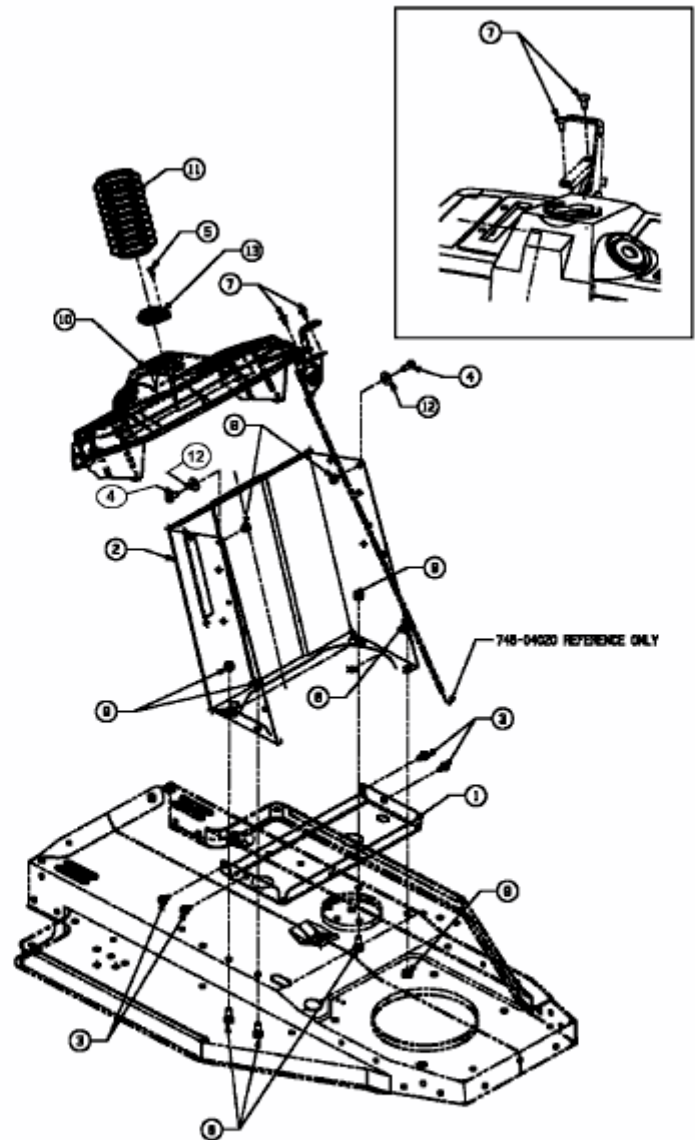

Fig.

E3-02135A-01