

RS 115/96 > 13D1452F600 (2005) > GESCHWINDIGKEITSREGELUNG

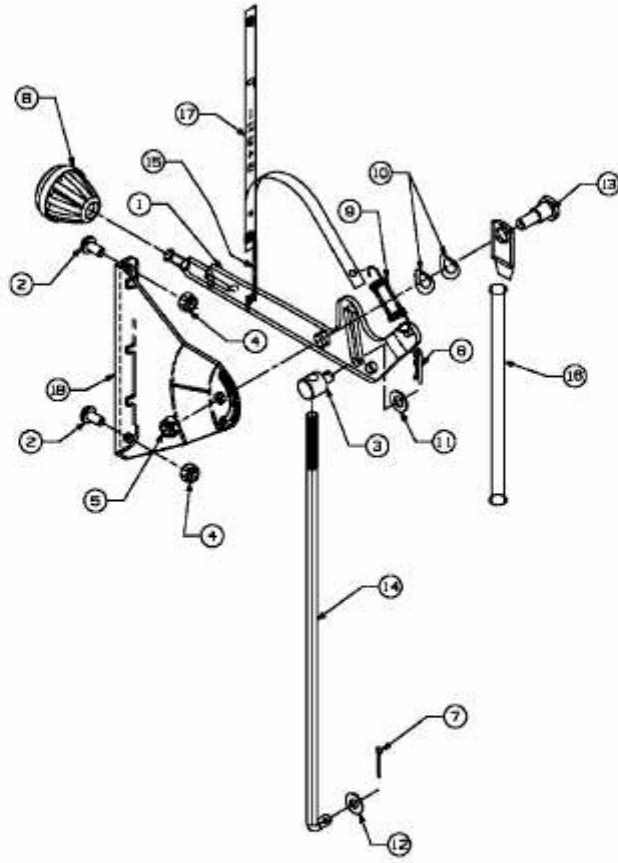

E3-02112A-01