

RS 125/96 > 13D1452F400 (2007) > ARMATURENBRETT

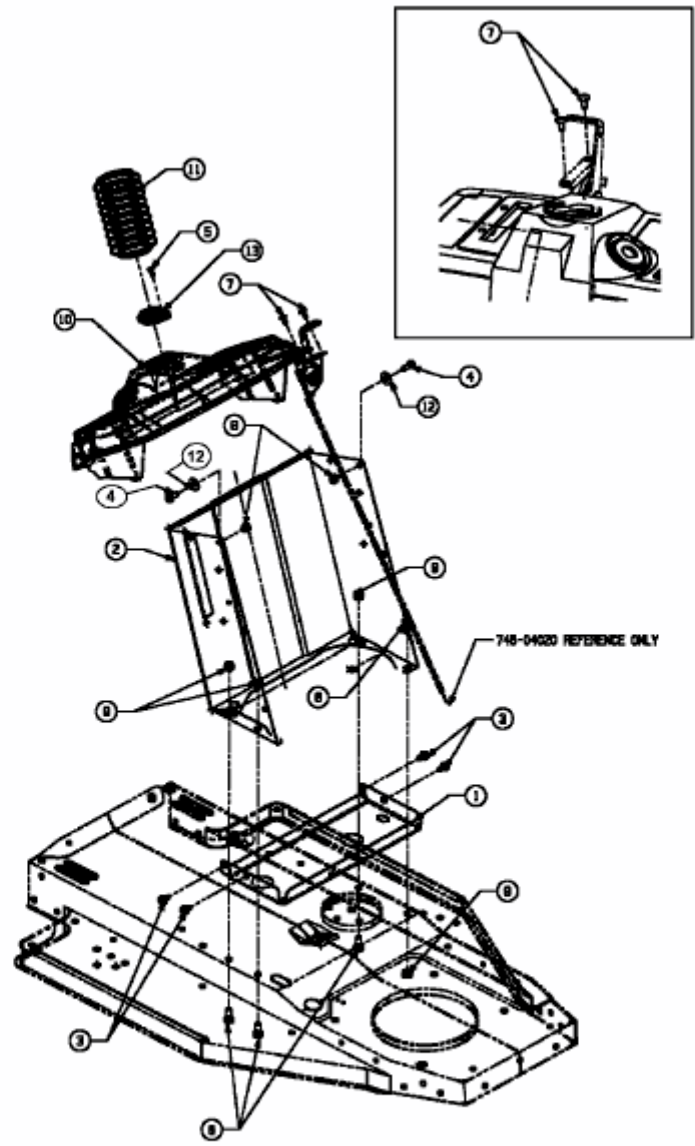

Fig.

E3-02135A-01