

RS 125/96 > 13D1452F400 (2007) > MOTORHAUBE 2-STYLE BIS 31.03.2008

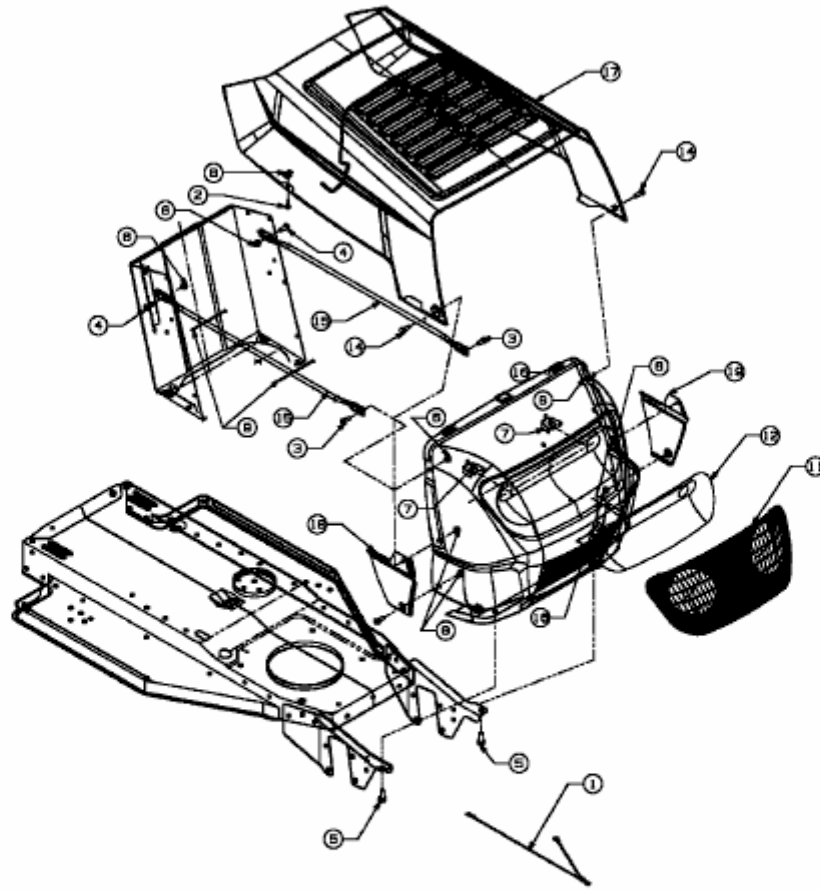

E3-02058A-01