

RH 125/92 > 13D1452E600 (2007) > TRITTBRETTBELAG

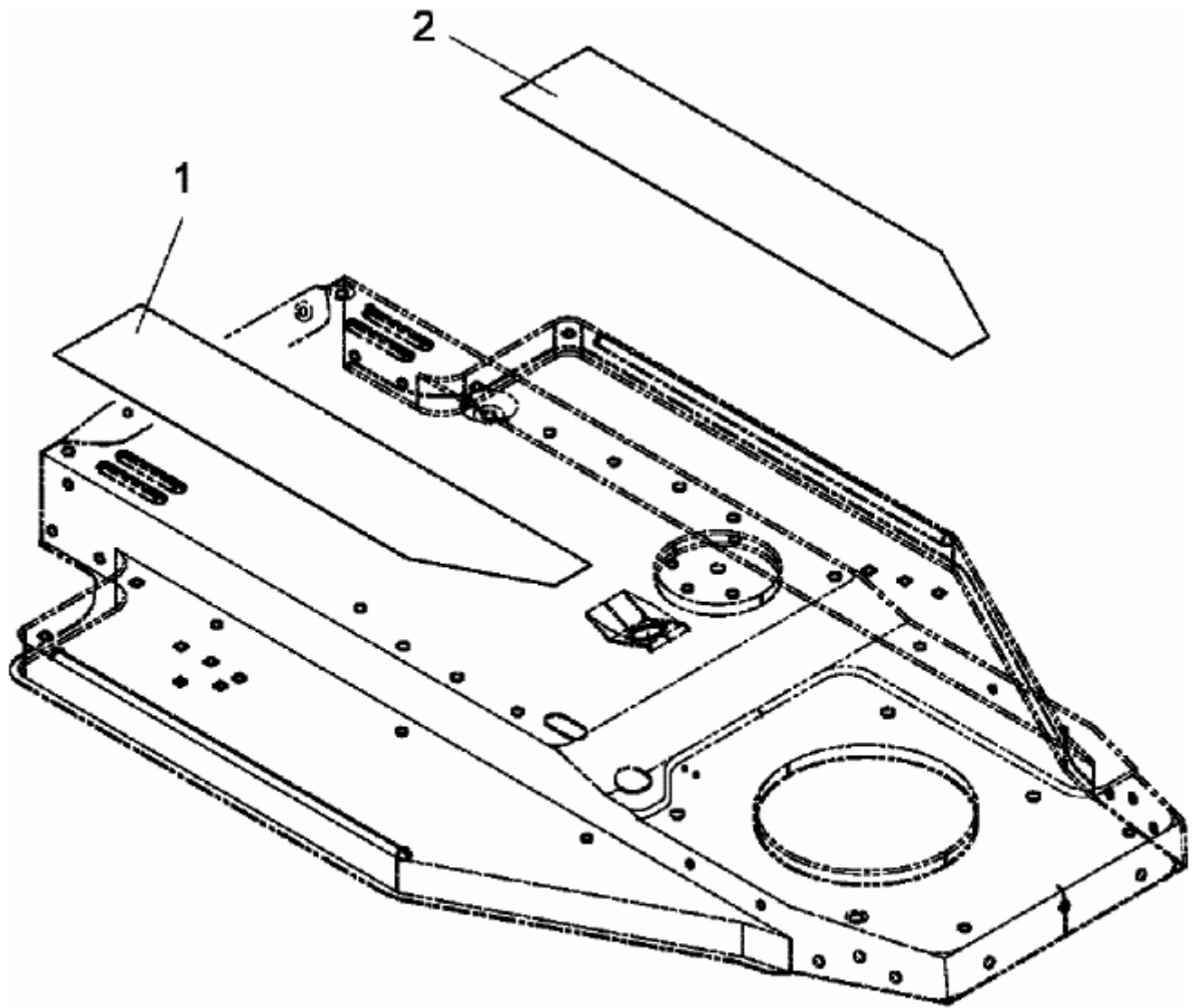

E3-02108A-01