

RH 125/92 > 13D1452E600 (2006) > FAHRANTRIEB, PEDALE

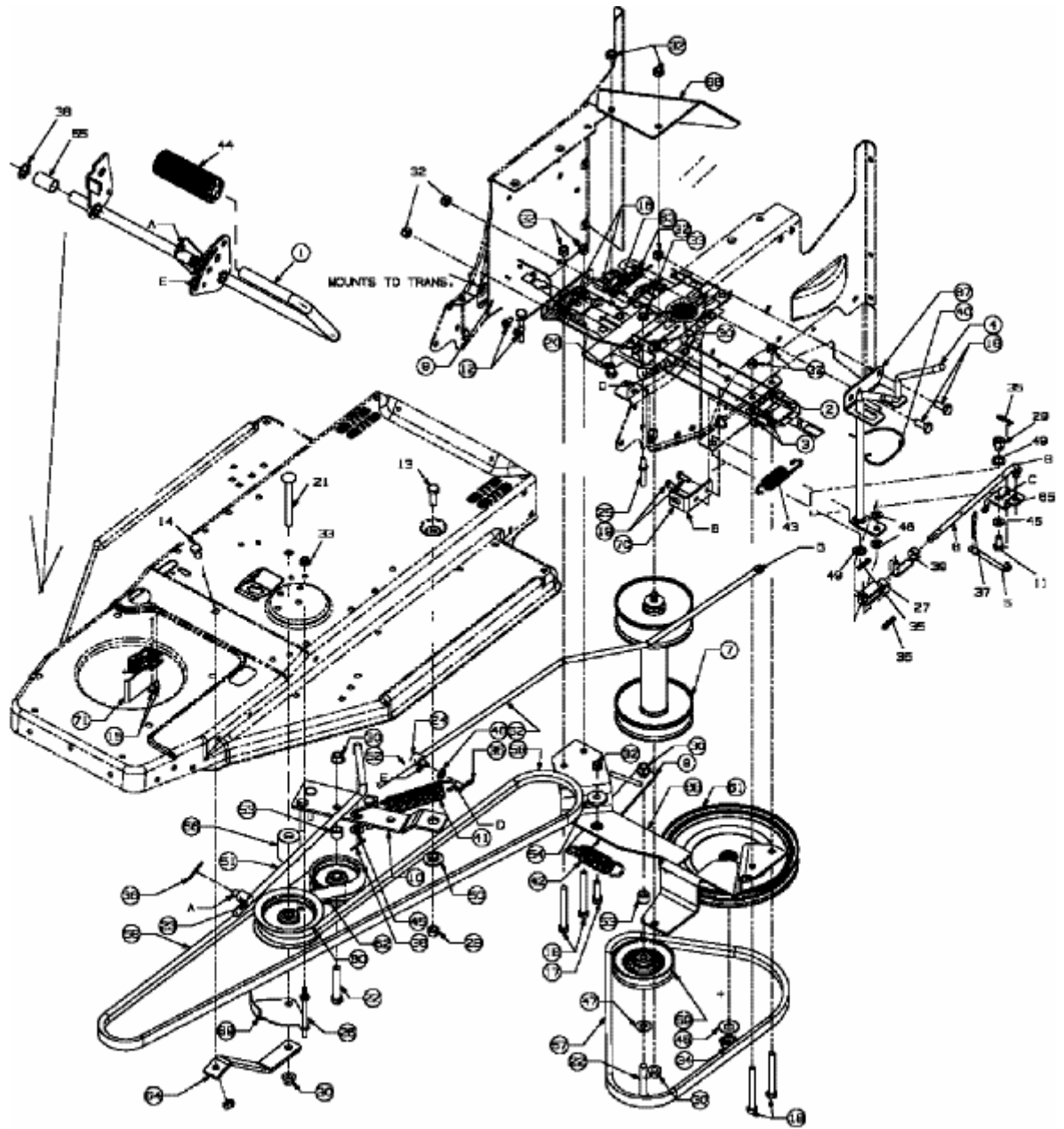

E3-02100B-01