

RH 125/92 > 13D1452E600 (2005) > MÄHWERKSEINSCHALTUNG

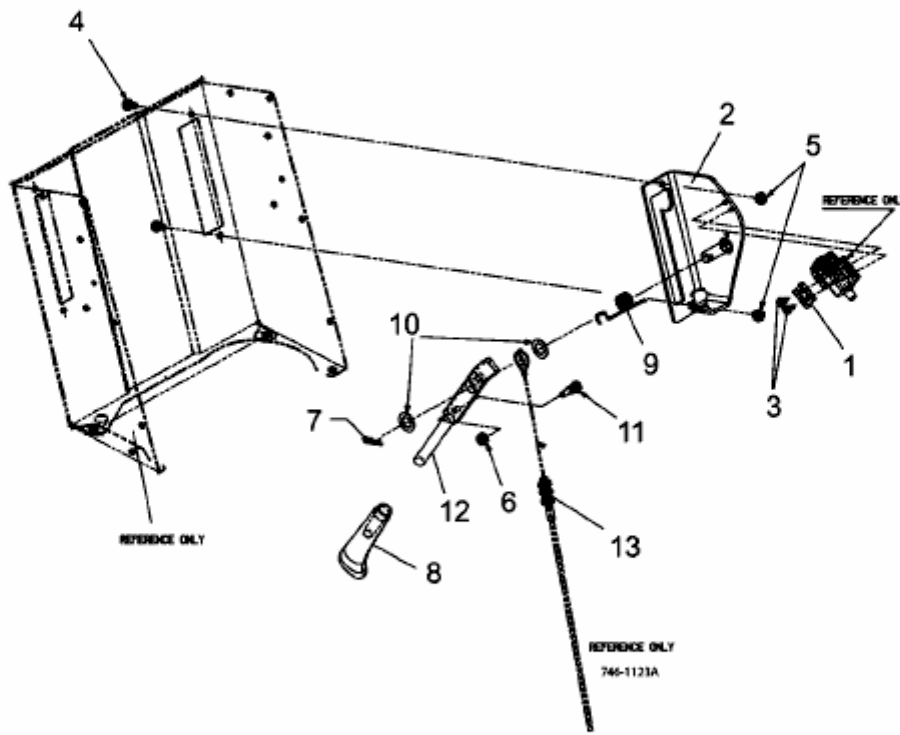

E3-02223A-01