

RH 125/92 > 13D1452E600 (2004) > MÄHWERKSEINSCHALTUNG

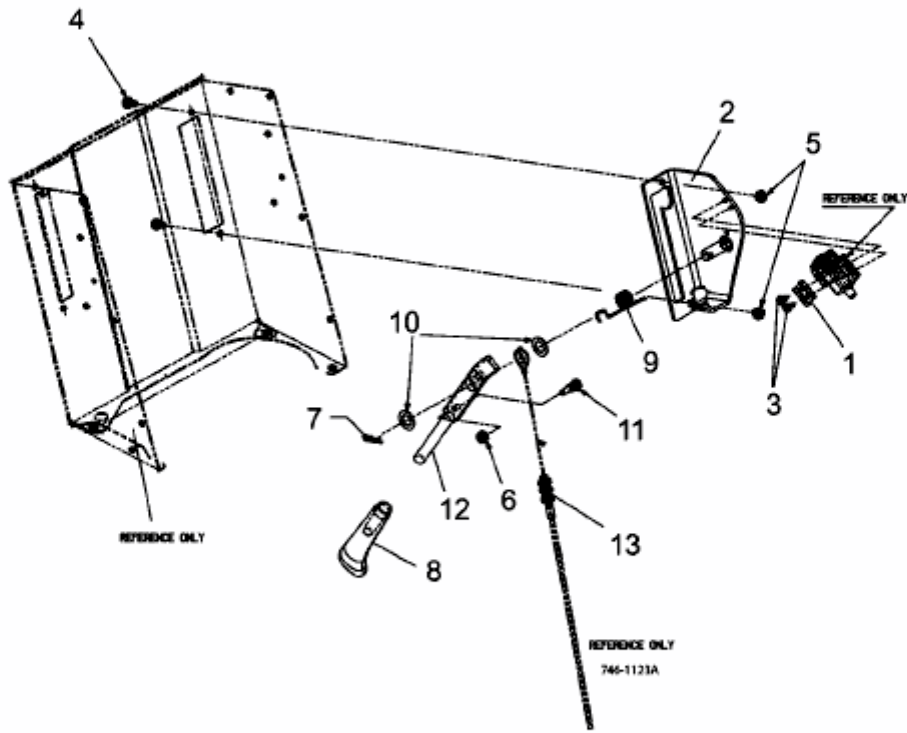

E3-02223A-01