

RH 125/92 > 13D1452E600 (2004) > GESCHWINDIGKEITSREGELUNG

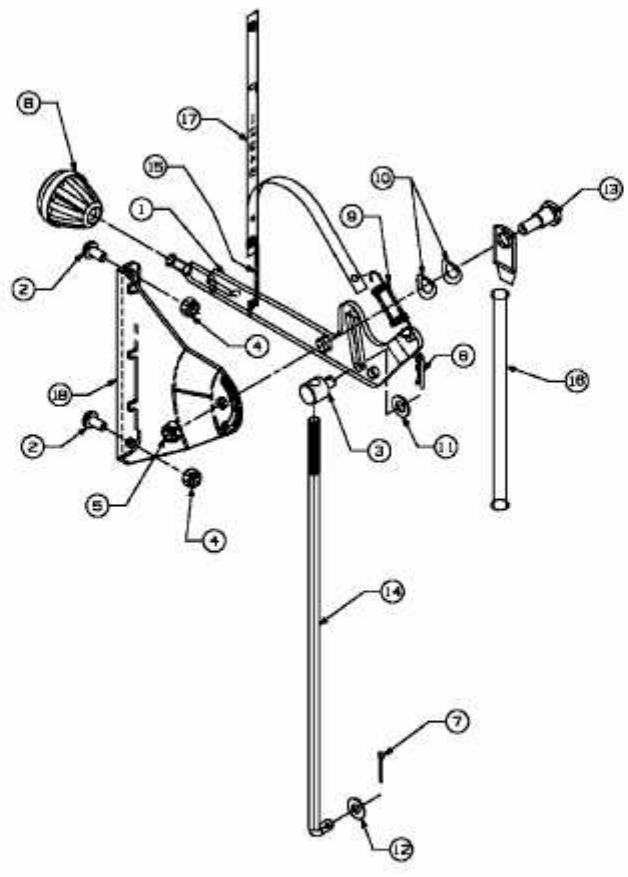

E3-02112A-01