

RH 115/76 > 13D1452C670 (2006) > GESCHWINDIGKEITSREGELUNG

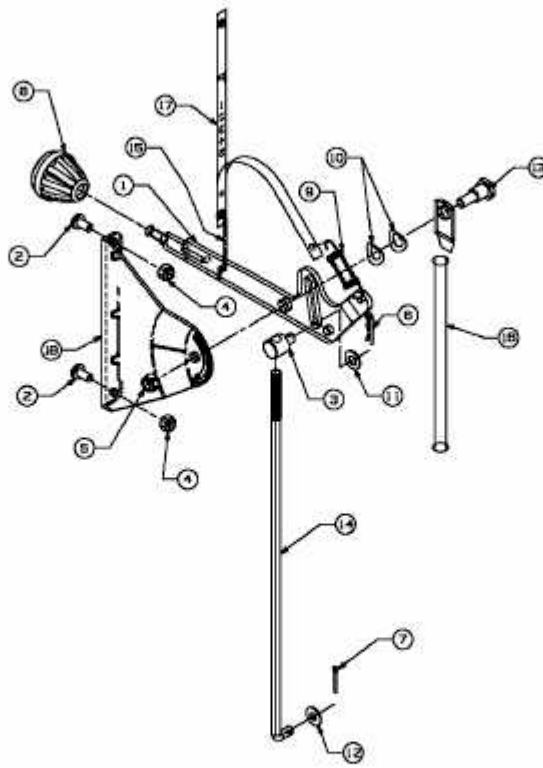

E3-02112A-01