

RH 115/76 > 13D1452C622 (2007) > ARMATURENBRETT

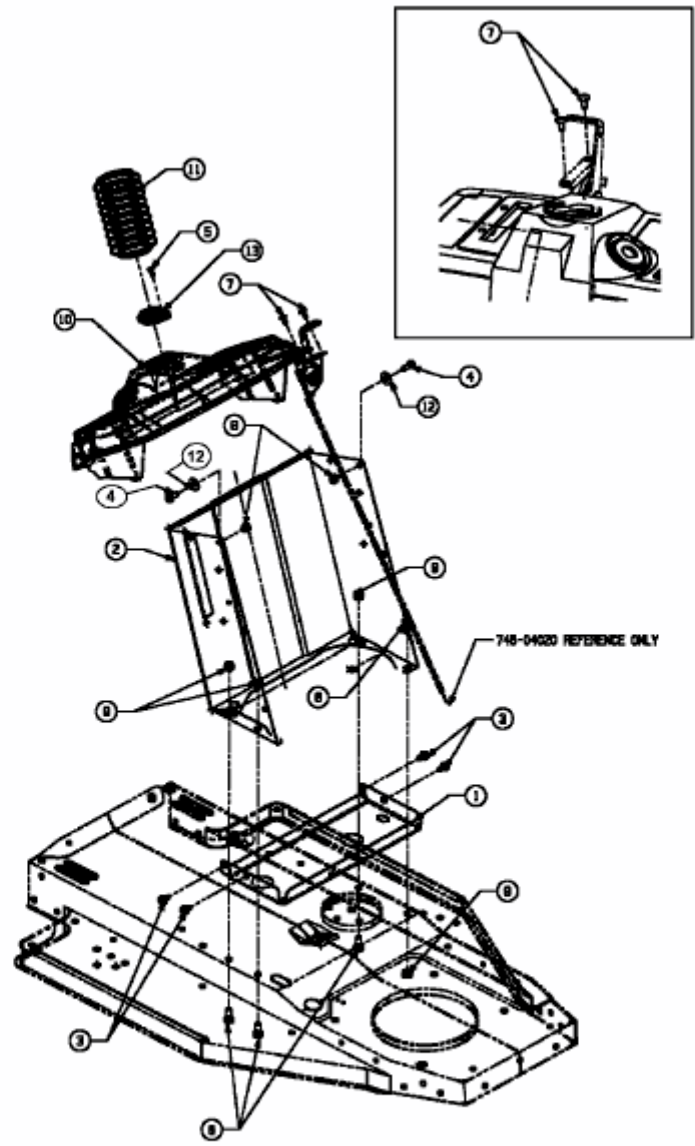

Fig.

E3-02135A-01