

AMH 1200 > 13D1452C619 (2005) > MOTORHAUBE 2-STYLE BIS 31.03.2008

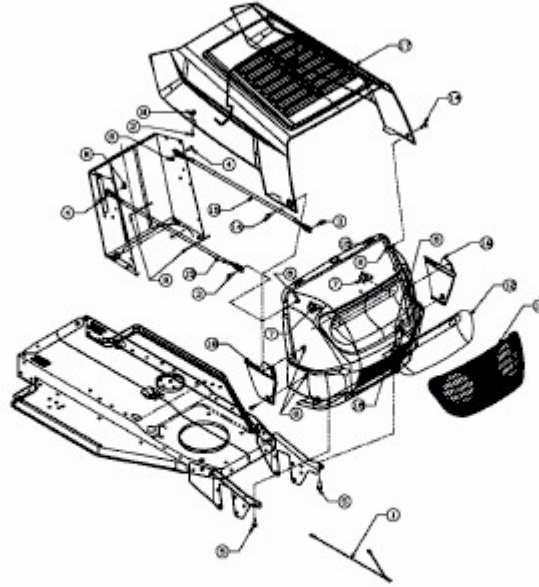

E3-02058A-01