

AMH 1200 > 13D1452C619 (2005) > GESCHWINDIGKEITSREGELUNG

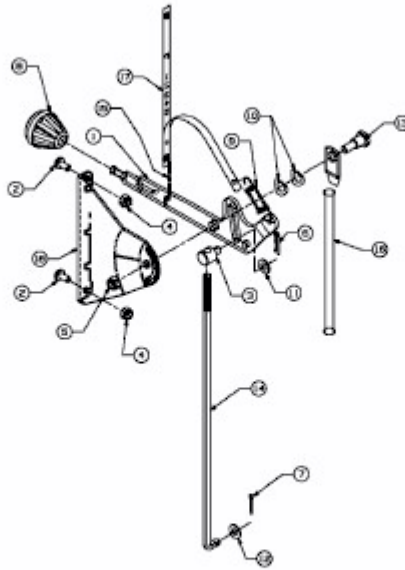

E3-02112A-01