

AMH 1200 > 13D1452C619 (2005) > LENKUNG

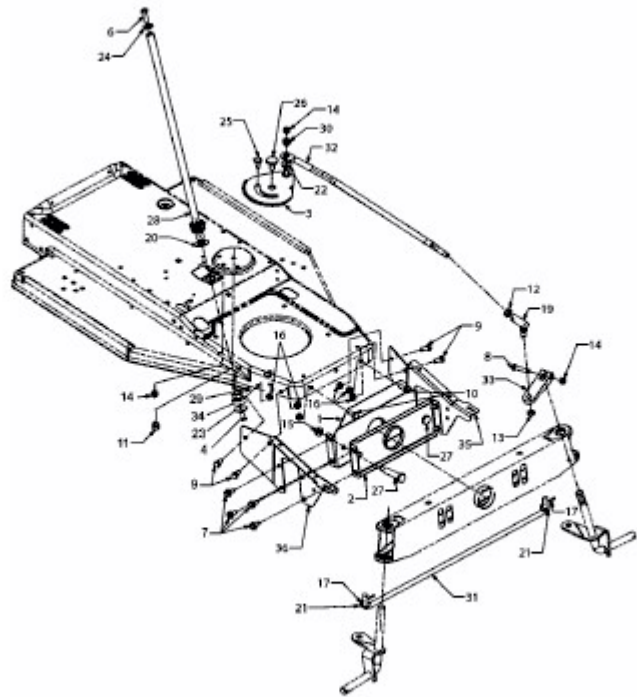

E3-02105A-01