

AMH 1200 > 13D1452C619 (2004) > MOTORKEILRIEMENSCHLEIBE

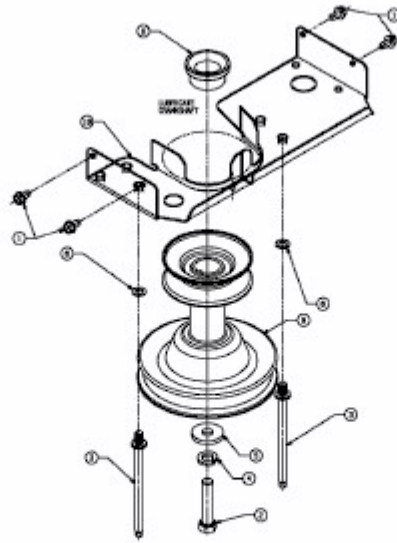

E3-02110A-01