

RH 115/76 > 13D1452C600 (2004) > GESCHWINDIGKEITSREGELUNG

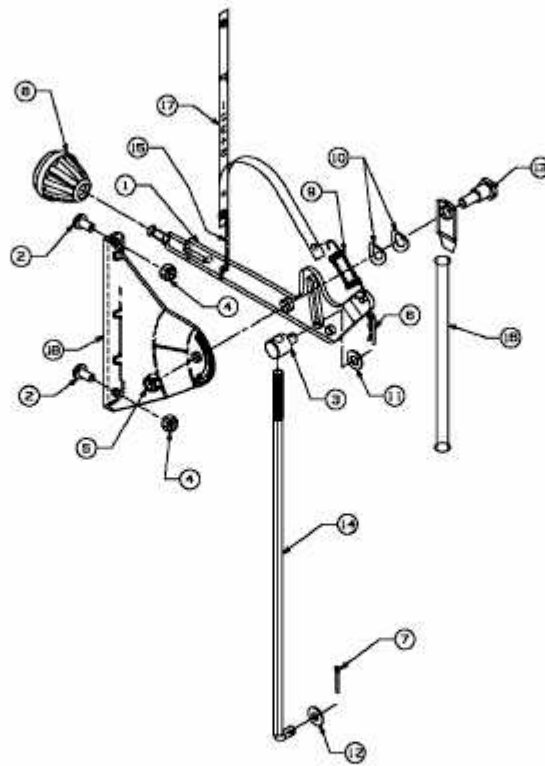

E3-02112A-01