

13D1452B620 (2007) > VORDERACHSE

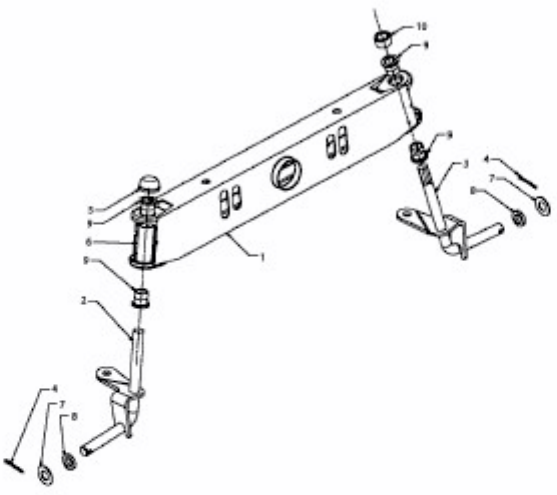

E3-02101A-01