

AM 1150 > 13D1452B619 (2005) > GETRIEBE

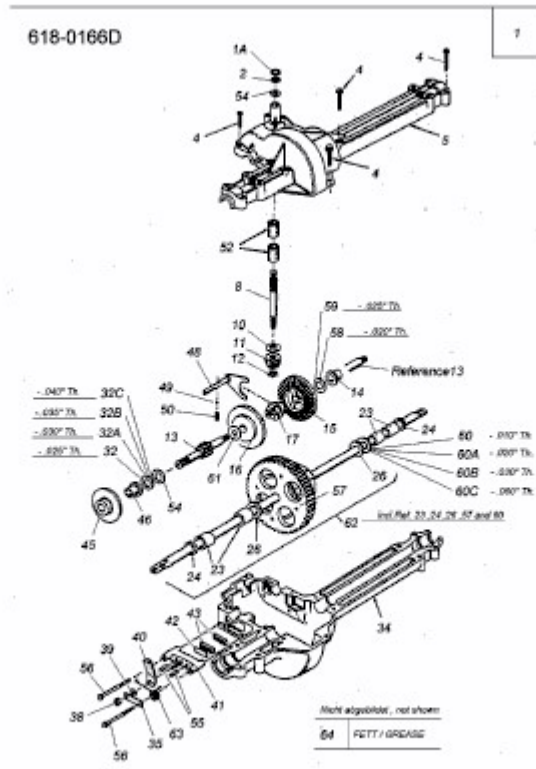

E3-01304B-01