

AM 1150 > 13D1452B619 (2005) > LENKRAD

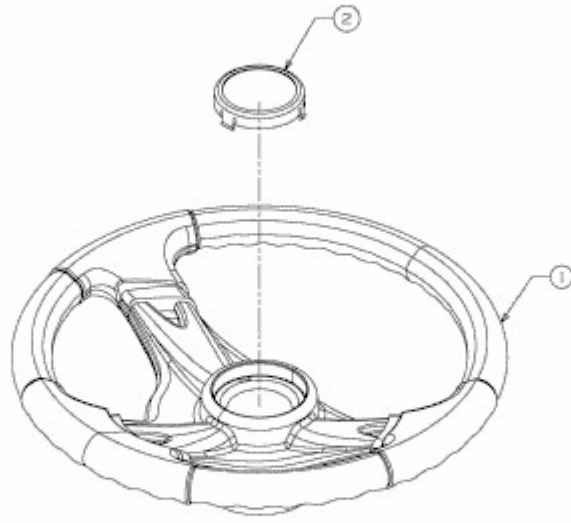

E3-02015A-01