

AM 1150 > 13D1452B619 (2005) > GESCHWINDIGKEITSREGELUNG

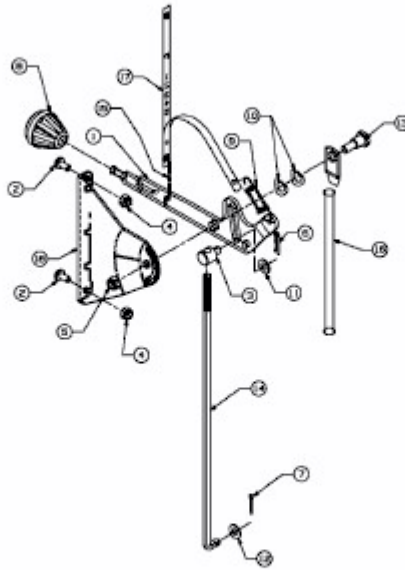

E3-02112A-01