

AM 1150 > 13D1452B619 (2005) > TRITTBRETTBELAG

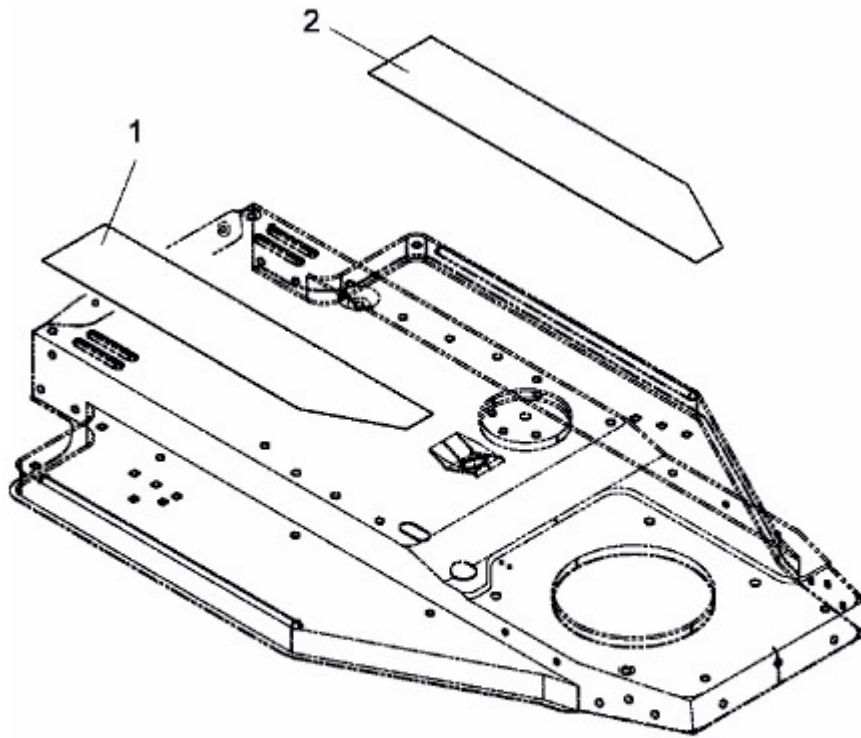

E3-02108A-01