

AM 1150 > 13D1452B619 (2004) > MOTORHAUBE 2-STYLE BIS 31.03.2008

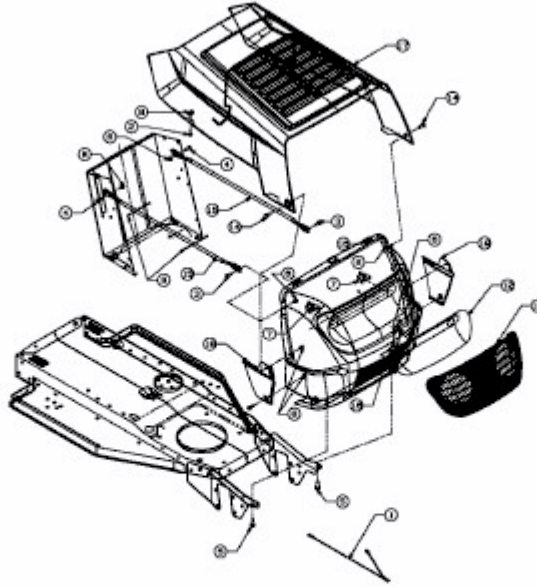

E3-02058A-01