

AM 1150 > 13D1452B619 (2004) > LENKUNG

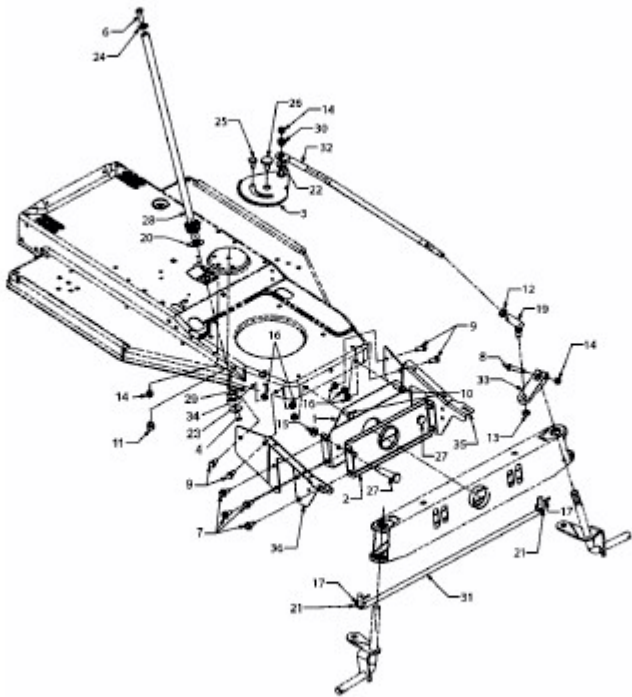

E3-02105A-01