

AM 1150 > 13D1452B619 (2004) > FAHRANTRIEB

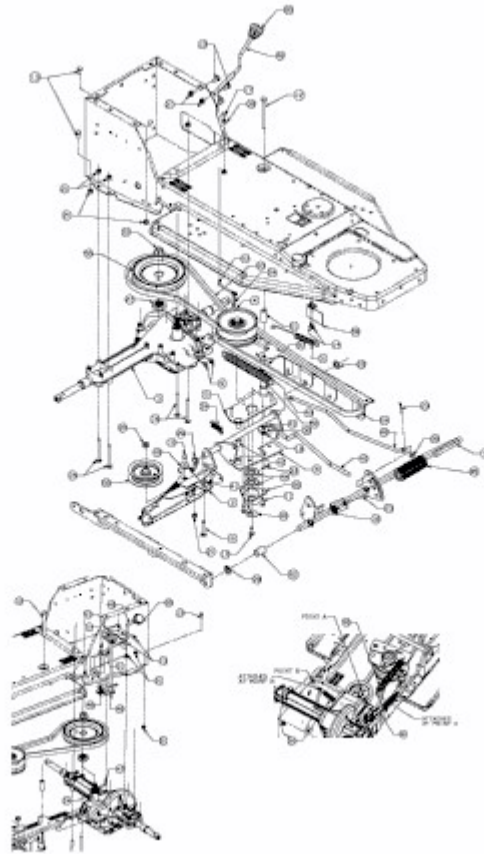

E3-02099A-01