

SPIDER 91 S > 13D1452B600 (2007) > GESCHWINDIGKEITSREGELUNG

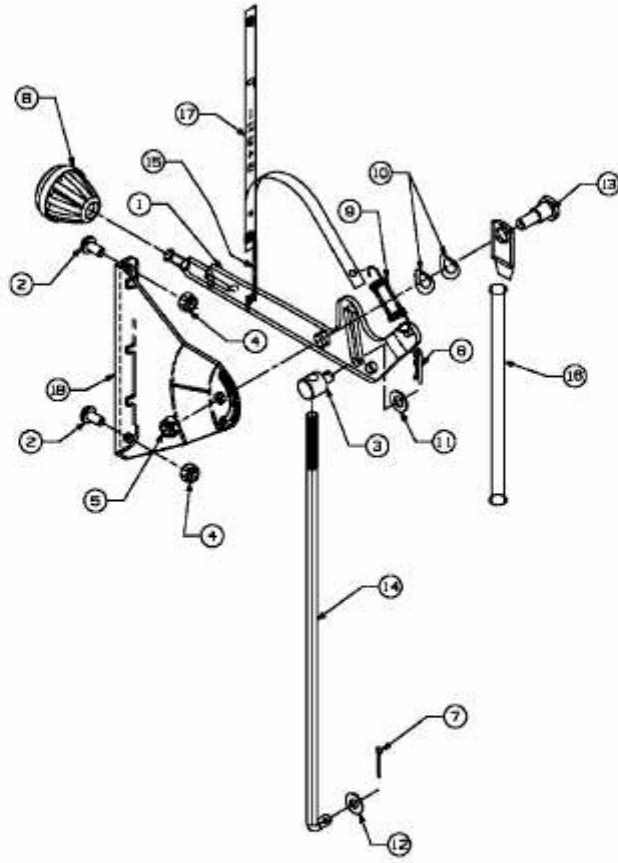

E3-02112A-01