

SPIDER 91 SD > 13D1452B467 (2008) > GESCHWINDIGKEITSREGELUNG

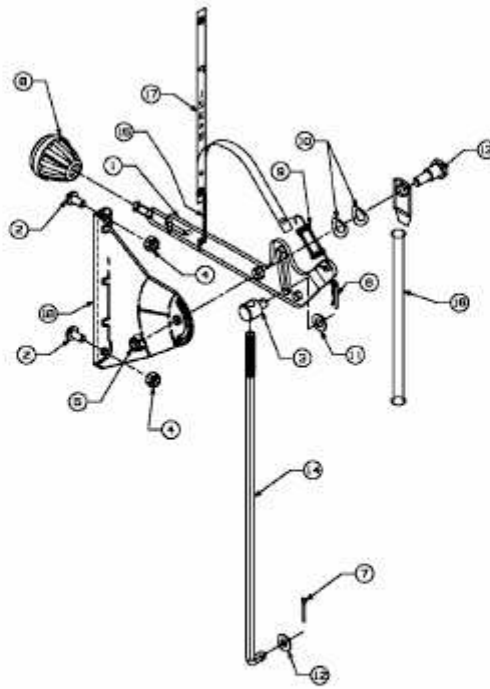

E3-02112A-01