

MASTERCUT 76 > 13D1450C459 (2007) > GESCHWINDIGKEITSREGELUNG

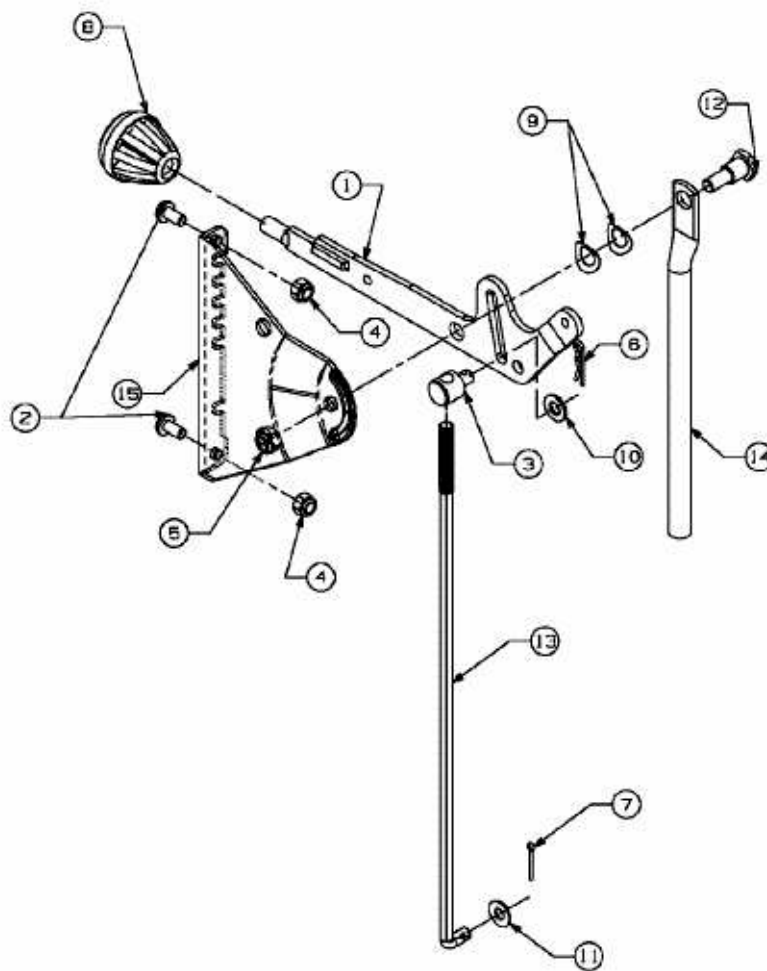

E3-02115A-01