

705 > 13CV509E611 (2006) > PEDALE

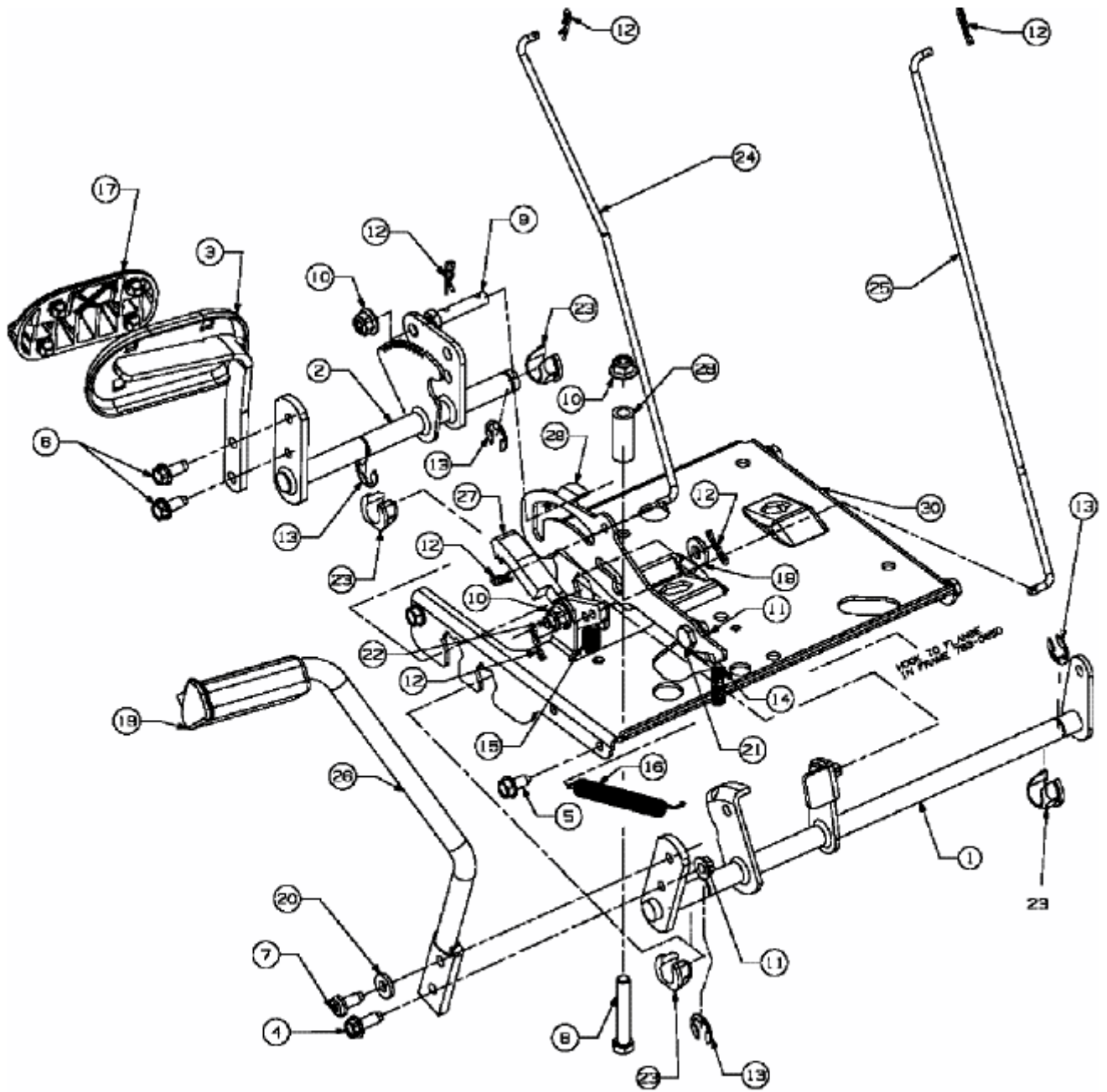

E3-02030B-01