

SMART RG 145 > 13CM765G600 (2014) > GESCHWINDIGKEITSREGELUNG

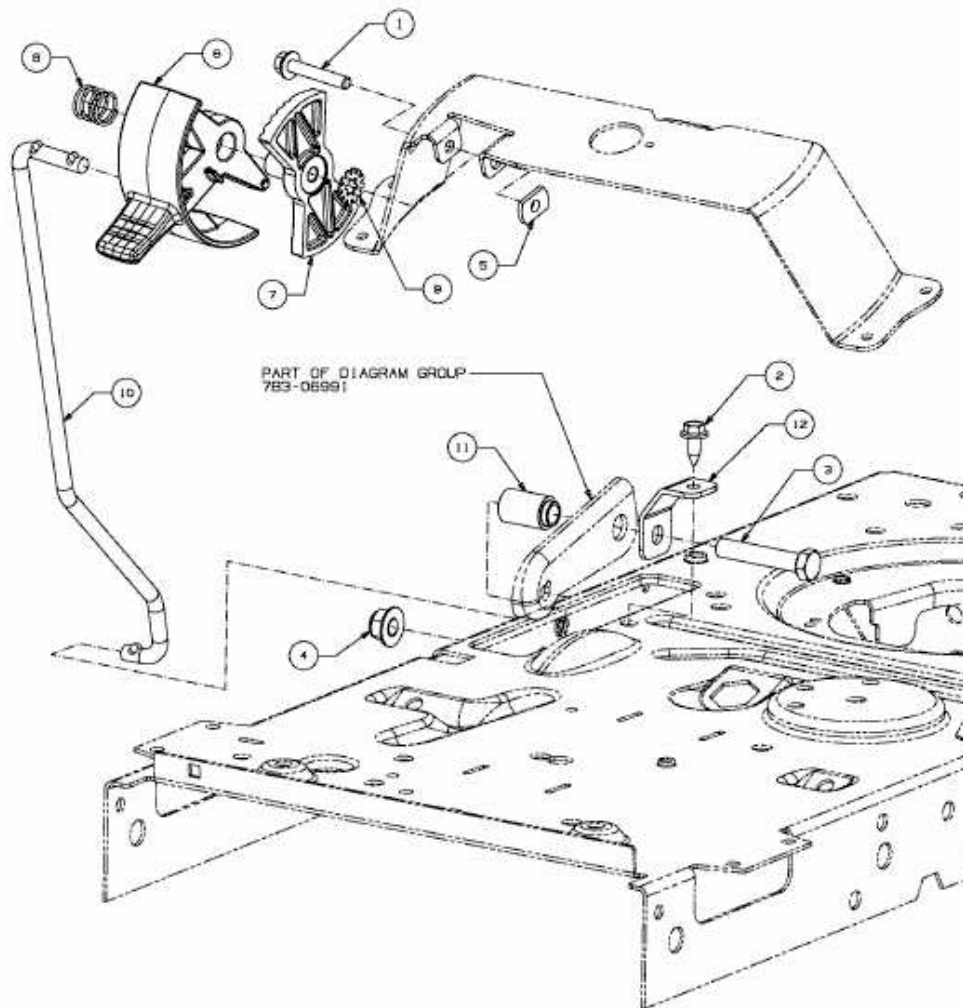

E3-07438B-01